



INSTRUCTION MANUAL

TX4500S

DIN size fully featured 5 watt UHF CB radio



ScanSuite™



Full Spectrum
Backlighting



Pure Sound



Advanced Signal
Management



Dynamic Volume
Control



Voice Inversion
Scrambler



Front and Rear
Mic Input



ScanSuite™ 
faster, smarter scanning

CONTENTS

SUPPLIED WITH.....	2	Using The Priority Channel While Scanning ..	14
INTRODUCTION	3	CTCSS & DCS.....	14
IMPORTANT INFORMATION CONCERNING UHF CB RADIO.....	3	Selective Calling.....	15
Possible Issues	3	Using SelCall.....	16
Emergency Channels.....	3	Quiet Mode	18
Telemetry Channels.....	3	Group Calling	19
FEATURES	4	Receive Only Channels	20
GENERAL OPERATION.....	5	Configuration Menu.....	23
Front Panel Controls.....	5	INSTALLATION	25
LCD Panel.....	5	DC Power Connection	26
Rear Panel	5	Microphone	26
Microphone	6	Antenna Installation.....	27
Keypad Functions.....	6	Wiring Diagram.....	27
Volume	6	NOISE SUPPRESSION.....	27
Selecting Channels.....	6	CTCSS TONE FREQUENCY CHART	28
Squelch.....	6	DCS TONE CHART.....	28
Signal Meter	6	UHF CB OPERATING FREQUENCIES	29
Transmitting.....	7	SPECIFICATIONS	30
Time-Out Timer	7	SC CONTRACT WARRANTY AGAINST DEFECTS... 31	
Backlighting.....	7		
Bandwidth Filter Settings	7		
Dynamic Volume Control	8		
Silent Squelch Tail	8		
Voice Scrambler	8		
Repeaters and Duplex Mode.....	8		
Priority Channels.....	9		
Scanning.....	10		
Open Scan	10		
Group Scan.....	11		
Additional Open/Group Scan Options	12		
Network Scan (Net-Scan)	12		

SUPPLIED WITH

TX4500S radio
DIN mounting kit
Screw pack
Microphone
Microphone clip
DC lead
Instruction manual

INTRODUCTION

Your GME TX4500S 80 channel radio is Australian designed and built and is the most advanced UHF Citizen Band radio available. Combining the very latest in electronic hardware with the most up-to-date computer aided design and manufacturing techniques has resulted in a mobile radio with outstanding specifications and performance.

The TX4500S's DIN sized case allows convenient installation into a dashboard or console and its strong die-cast aluminium chassis makes it the most robust radio of its kind. With just three rotary controls and five touch keys, the TX4500S's extensive features are easy to operate.

IMPORTANT INFORMATION CONCERNING UHF CB RADIO

The use of the Citizen Band radio service is licensed in Australia by the ACMA Radio communications (Citizens Band Radio Stations) Class Licence and in New Zealand by the Ministry of Economic Development New Zealand (MED). A General User Radio Licence for Citizens Band radio and operation is subject to conditions contained in those licences.

The class licence for users and equipment operating in the CB/PRS 477 MHz band has been amended. This radio meets the new 80 channel standard.

In simple terms the same amount of spectrum is available; however, radio transceivers can now operate in a narrower bandwidth and hence use less spectrum. These radios are generally referred to as narrowband or 12.5 kHz radios. By using 12.5 kHz channel spacing instead of 25 kHz, the 40 channels originally allocated can now be expanded to 80 channels thereby doubling the channel capacity and relieving congestion in the UHF CB/PRS band.

Original 40 channel wideband Radios will continue to operate on the original 40 channels, however they will not be able to converse on the newer channels 41 – 80. The newer narrowband radios will be able to converse with all older 40 channel wideband radios on all channels 1 to 40 as well as the newer channels allocated from 41 to 80.

The mixing of narrowband and wideband radios in the same spectrum can cause some possible operating issues of interference and varying levels of received volume.

POSSIBLE ISSUES

When a new narrowband radio receives a transmission from an older wideband radio the speech may sound loud and distorted – simply adjust your radio volume for best performance.

When an older wideband radio receives a signal from a new narrowband radio, the speech may sound quiet – simply adjust your radio volume for best performance.

Depending on how close your receiving radio is to another transmitting radio, there can be interference from the transmitting radio if it is using a channel adjacent to the channel you are listening to. Simply try going up or down a few channels from the currently selected channel.

The above situations are not a fault of the radio but a symptom of operating wideband and narrowband radios in the same bandwidth. This possible interference will decrease over time as the population of wideband radios ages and decreases.

Further information and updates are available from the Australian Communications and Media Authority (ACMA) at www.acma.gov.au and the Ministry of Economic Development (MED), Radio Spectrum Management at: www.rsm.govt.nz

EMERGENCY CHANNELS

The ACMA has allocated channels 5/35 for emergency use only. Channel 5 is the primary Simplex Emergency Channel. Where a Channel 5 repeater is available, you should select Duplex on CH 5.

NOTE: Channel 35 is the input channel for the Channel 5 repeater therefore Channel 35 should also not be used for anything other than emergency transmissions.

TELEMETRY CHANNELS

ACMA regulations have allocated channels 22 and 23 for telemetry only applications and have prohibited the transmission of speech on these channels. Consequently your radio has a transmit inhibit applied to channels 22 and 23.

In the event additional telemetry/telecommand channels are approved by the ACMA, these channels shall be added to those currently listed where voice transmission is inhibited. Currently transmissions on channels 61, 62 and 63 are also inhibited and these channels are reserved for future allocation.

FEATURES

TRANSMIT (TX)

Individually Programmable DUPLEX Function: User selectable for only those individual channels in your area that have repeaters, leaving the others free for use as extra simplex channels.

RECEIVE (RX)

User Selectable Wide/Narrow Receive Filter

User Programmable Receive-Only Channels: Use the radio's front panel controls to program up to 95 of your own receive-only channels (in 5 banks of 19 channels) within the 403-520 MHz frequency range.

SCANNING AND MEMORY FUNCTIONS

Microprocessor Controlled Frequency Synthesiser: Allows user programmable control of scanning, channel memories and selected feature options.

Priority Channels: Two user programmable Priority channels allow your working channels to be instantly recalled at the press of a key.

Programmable Scan Function: Scans the selected UHF CB channels with Group, Open and Network Scan functions available.

Auto Skip: Temporarily removes annoying busy channels from the scan group.

SIGNAL PROCESSING

Digital Signal Processing: Measures, filters and compresses standard analogue audio signals and converts them into digital format. Allows advanced RF and audio processing techniques to be applied to maximise the radio's performance.

Advanced Signal Management (ASM): Identifies interference caused by strong local signals on adjacent channels and prevents it from opening your Squelch. ASM also minimises distortion on reception by fine tuning the receiver frequency to match that of an incoming signal. This prevents your Squelch from opening to unwanted interference and ensures incoming signals remain clear and undistorted even when slightly off-frequency.

Dynamic Volume Control (DVC): Automatically compensates for variations in received audio level resulting in a constant audio output level to the speaker.

PRIVACY FUNCTIONS

Voice Inversion Scrambler: When activated, scrambles your voice so that communications are only intelligible to others using the same scrambler technology.

In-Built CTCSS & DCS: User selectable Continuous Tone Coded Squelch and Digital Coded Squelch System option provides silent channel operation on individual channels.

In-Built SelCall with Quiet Mode: Provides selective calling of individuals or groups with fully user-adjustable 5 tone transmitted SelCall Ident. Also allows alphanumeric naming of up to 10 Idents for easier caller identification.

PHYSICAL PROPERTIES

Overvoltage Protection: Special overvoltage detection circuitry protects the radio and warns of excessive voltage conditions by flashing the display.

Dual Microphone Input Sockets: Front and rear microphone sockets to match most installation needs. Both sockets can be used independently or simultaneously.

USER CONTROLS AND INTERFACE

High Contrast Liquid Crystal Display: Fully detailed LCD provides a visual indication of the selected channel and all selected functions at a glance.

Full Spectrum Backlighting: User adjustable, totally customisable colour backlight settings to match the vehicle's dashboard lighting or drivers preference.

GENERAL OPERATION

FRONT PANEL CONTROLS

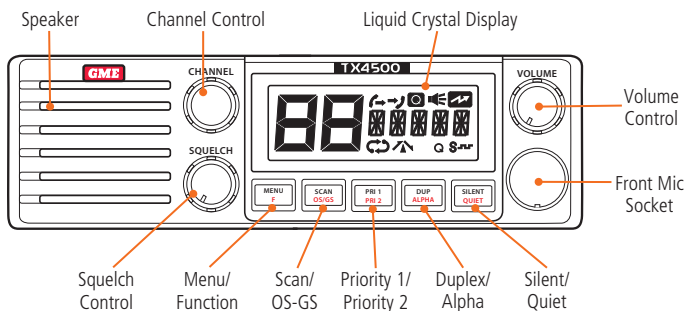

LCD PANEL

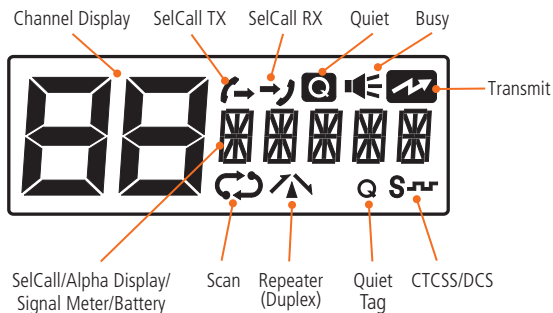

REAR PANEL

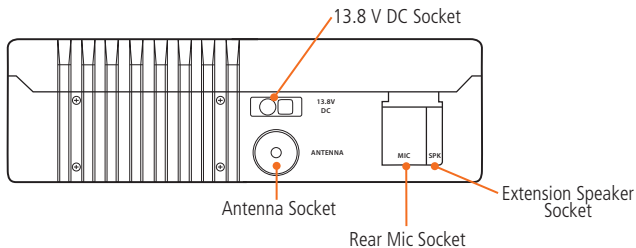

MICROPHONE

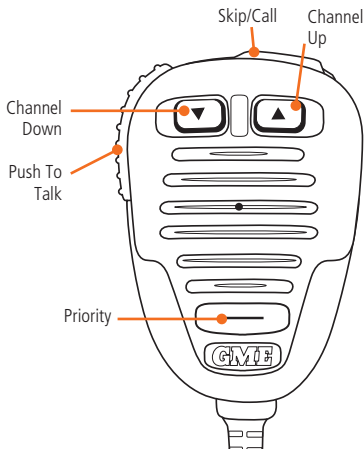

KEYPAD FUNCTIONS

All controls on the TX4500S front panel have multiple functions. The primary functions are labelled in BLACK, while the secondary functions are labelled in RED. To access a primary function simply press the required key.

To access a secondary function, briefly press the **F** key followed immediately by the required key.

NOTE: When using the **F** key to access other functions, **F** is displayed to indicate that 'Function' mode is activated. If the required function is not selected within 6 seconds the **F** key selection will time out with a low beep and **F** will disappear from the display.

More detailed descriptions of these key functions are included in this 'General Operation' section.

VOLUME

Rotate the **Volume** control clockwise past the click to turn the radio on. Rotate the **Volume** control left or right to adjust the volume.

If no sound is heard, rotate the **Squelch** control fully counter-clockwise to un-mute the radio then adjust the volume while listening to the background noise. When finished, readjust the **Squelch** control to re-mute the radio.

NOTE: At the minimum volume setting there is still sufficient volume to be heard in a quiet cabin environment.

SELECTING CHANNELS

To select the required channel, rotate the **Channel** control. Rotate the control clockwise to select a higher channel or counter clockwise to select lower channels. The selected channel is displayed on the LCD.

SQUELCH

The Squelch is used to eliminate any annoying background noise when there are no signals present. The Squelch can be opened or closed using the **Squelch** control. When the Squelch is open the receiver's background noise can be heard and the **🔊** symbol is displayed. When the Squelch is closed the receiver remains quiet while there are no signals present but any incoming signals will override the Squelch and be heard in the speaker.

Adjusting the Squelch level

The TX4500S features a continuously variable Squelch control system allowing the user to set the Squelch for optimum performance.

To adjust the Squelch, first rotate the **Squelch** control fully counter-clockwise until the background noise is heard and the **🔊** indicator is displayed on the LCD. Now advance the **Squelch** control slowly clockwise until the noise is just extinguished and the **🔊** indicator disappears. At this point the receiver will remain quiet while no signals are present but an incoming signal will override the Squelch and be heard in the speaker. As the **Squelch** control is advanced further clockwise the Squelch action is progressively increased and stronger incoming signals are needed to overcome it.

NOTE: If an incoming signal is very weak and is close to the minimum Squelch level it may become broken or 'chopped' by the Squelch action. To prevent this simply turn the **Squelch** control fully counter-clockwise to open the Squelch. This will allow a clearer signal.



SIGNAL METER

The signal meter indicates the relative strength of the incoming signal in numerical format. Signal strengths are displayed on the lower right of the channel display in values from 0 to 9. Signals above strength 9 are displayed as 9+.

NOTE: Refer to the **Configuration** menu for other options that can be displayed in this location.

TRANSMITTING

Prior to transmitting, always check the channel is not being used. This can be done by listening to the channel or by visually checking that the  icon is not visible or the signal meter is not indicating a signal.

To transmit, press the **PTT** switch on the microphone. The  icon will appear. Hold the microphone about 5-8 cm from your face and speak at a normal voice level. The microphone is quite sensitive so it is not necessary to raise your voice or shout. Release the **PTT** when you have finished talking. The  icon will disappear.

IMPORTANT: Always listen to ensure the channel is free before transmitting.

TIME-OUT TIMER

The radio has a built-in time-out timer that automatically limits transmissions to a maximum of 3 minutes of continuous operation. This feature is required by the ACMA to prevent accidental blocking of the frequency should your PTT switch become jammed or be otherwise pressed accidentally. The time-out period can be changed by your dealer.

When the time-out timer activates, the radio will beep for 5 seconds then the  icon will flash continuously. Normal operation will be restored once the PTT is released.

BACKLIGHTING

The Liquid Crystal Display and keys are backlit for easy viewing at night. The backlight remains on while the radio is switched on.

Adjusting the Backlighting

The backlight brightness and colour can be adjusted for personal preference.

To make adjustments to the backlighting, press and hold the **Channel** control for several seconds. **BKLG**T will be displayed indicating the Brightness setting is selected. Briefly press the **Channel** control to cycle through the available settings. Rotate the **Channel** control left or right to adjust the current setting.

There are three backlight settings available;

BKLGT (**Brightness Setting**): Provides a continuously variable brightness adjustment from very dim to full brightness.

COLOR (**Colour Setting**): Provides a continuously variable colour spectrum change via a smooth blend of colours.

WHITE (**Whiteness Setting**): Controls the whiteness or colour saturation of the selected colour from full colour to white (no colour).

TIP: For the deepest colour range, reduce the 'WHITE' setting.

After making your selection, press and hold the **Channel** control to return to normal operation.

NOTE: The backlight setting function will automatically time-out after 6 seconds if no further adjustments have been made.

BANDWIDTH FILTER SETTINGS

To accommodate the blending of the newer narrowband UHF CB 80 channel plan with the original 40 channel wideband system, your radio is fitted with two user-selectable receiver bandwidth filters. While either of these will provide superb receive audio, selecting the wide filter will further increase the tolerance of the receiver to 40 channel wideband radios that might otherwise sound over-modulated or slightly off frequency on channels 1 – 40. Selecting the narrow receive filter will increase the selectivity of the radio to strong interfering signals from adjacent channels.

To select the desired filter, press and hold the **MENU** key to enter the menu, then press the **MENU** key repeatedly until **NBFLT** (Narrowband Filter) or **WBFLT** (Wideband Filter) is displayed. Rotate the **Channel** control left or right to make the desired selection.

When finished, briefly press the **PTT** to exit from the Menu.

Narrowband filter selected



Wideband filter selected



NOTE: The wideband receiver filter setting is only applied to channels 1 – 40. Channels 41 – 80 always use the narrowband filter.

DYNAMIC VOLUME CONTROL (DVC)

The modulation level of signals heard on the UHF CB band has always varied considerably resulting in noticeable differences in received audio volume between stations. Generally users have compensated for this by adjusting the volume control for each incoming signal. With the introduction of 80 channel narrowband transmissions that use lower levels of modulation, the diversity in received audio volume is likely to increase further.

Your radio is able to automatically compensate for these variations in received audio level by utilising a **Dynamic Volume Control**. When activated, this feature automatically compensates for variations in received audio level resulting in a constant audio output level to the speaker.

To activate the **Dynamic Volume Control**, press and hold the **MENU** key to enter the menu, then press the **MENU** key repeatedly until **DVCOF** (Dynamic Volume Control Off) or **DVCON** (Dynamic Volume Control On) is displayed. Rotate the **Channel** control left or right to make the desired selection.

When finished, briefly press the **PTT** to exit from the menu.

Dynamic Volume Control ON

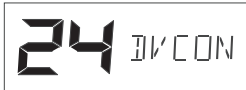

Dynamic Volume Control OFF

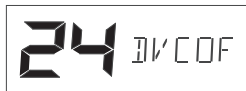

SILENT SQUELCH TAIL

The Squelch Tail is the short burst of noise that is heard in the speaker at the end of a transmission before the Squelch closes.

To some it is a reassuring confirmation that it's their turn to transmit, but in some applications it may be an annoyance especially when listening through an earpiece or headphones.

The Silent Squelch Tail function removes this Squelch Tail, reducing it to a faint click as the Squelch closes.

To Enable or Disable the Silent Squelch Tail

1. Press and hold the **MENU** key to enter the menu.
2. Press the **MENU** key repeatedly until 'SSTxx' is displayed (where xx = ON or OF).
3. Rotate the Channel control clockwise to enable the Silent Squelch Tail. 'SSTON' will be displayed and the Squelch Tail will now be silent.
4. Rotate the Channel control counter-clockwise to disable the Silent Squelch Tail. 'SSTOF' will be displayed and the Squelch Tail will be restored.
5. Press the **PTT** to exit the menu.

VOICE SCRAMBLER

Your radio incorporates a simple voice scrambler using band inversion. The scrambler is compatible with the majority of scramblers used by other manufacturers, allowing you to enjoy scrambled communications with owners of non-GME radios. Once the scrambler has been activated your transmission and reception will only be intelligible to others using the same scrambler technology.

To enable or disable the voice scrambler:

1. Press and hold the **MENU** key until the radio beeps.
2. Briefly press the **MENU** key repeatedly until **ENCOF** or **ENCON** is displayed.
3. Rotate the **Channel** control left or right to make your selection. Select **ENCON** to activate the scrambler encoder or **ENCOF** to disable it.
4. Press the **PTT** to exit the menu.



Scrambler Encoder OFF

Scrambler Encoder ON

REPEATERS AND DUPLEX MODE

Duplex operation allows the radio to transmit on a different frequency to that which it receives. This allows operation through repeater stations.

Simplex/Duplex Range Comparison

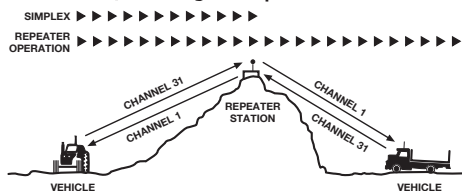

A repeater station consists of a linked transmitter/receiver combination installed in a prominent location. The repeater is designed to receive signals on a designated channel and retransmit them on another channel. Repeaters are usually mounted on hills or tall buildings. The increased elevation greatly improves both the receiving and transmitting range of the repeater allowing it to receive and retransmit signals to radios that would otherwise be out of range of each other.

Normally, UHF radios transmit and receive on the same frequency – known as Simplex operation. However to communicate through repeaters, your radio must be able to transmit and receive on different channels – otherwise known as Duplex operation. Your radio is fitted with a **Duplex** key to allow you to operate through repeaters.

The Duplex function can only be selected on channels 1–8 and 41–48 as these are the channels that have been allocated for repeater use. When **Duplex** is selected, your radio receives on the selected channel (e.g. CH 1) but transmits 30 channels higher (CH 31). The repeater hears your signal on CH 31 and retransmits it on CH 1 for others to hear.

Channel Selected	Receive Channel	Transmit Channel
1	1	31
2	2	32
3	3	33
4	4	34
5*	5*	35*
6	6	36
7	7	37
8	8	38
41	41	71
42	42	72
43	43	73
44	44	74
45	45	75
46	46	76
47	47	77
48	48	78



*Emergency channel only

Your radio allows you to enable or disable Duplex mode on individual repeater channels. In this way any repeater channels that are not being used with repeaters in your area can be used in Simplex mode for normal direct radio-to-radio communications.

To Enable Duplex on a Repeater Channel

1. Select the required repeater channel (1-8, 41-48).
2. Briefly press the **DUP** key. The duplex symbol  will appear on the display accompanied by a high beep.

To Remove Duplex from a Repeater Channel

1. Select the required repeater channel (1-8, 41-48). If Duplex is currently selected, the Duplex symbol  will be displayed.
2. Briefly press the **DUP** key. The Duplex symbol  will disappear from the display accompanied by a low beep.

IMPORTANT: Channels 1-8, 31-38, 41-48 and 71-78 should only be used in Simplex mode if there are no repeaters in or near your location that operate on the selected channel. In particular, avoid operating in Simplex mode on any of the repeater input channels 31-38 and 71-78 unless you are absolutely sure that there are no repeaters in range using that channel. Inadvertently transmitting on an active repeater input frequency in Simplex mode could cause interference to other users on that repeater that would not be audible to your radio.

PRIORITY CHANNELS

The Priority channel feature allows you to instantly recall any of the 80 channels in your radio. This feature can be used to provide instant access to your working channel or your local repeater channel at the press of a key. It can also be used in conjunction with the Group Scan function.

Your TX4500S has provision for two separate Priority channels.

To Store Priority Channel 1

1. Select the required channel.
2. Press and hold the **PRI 1** key. The channel number will flash then a high beep will be heard as the channel is stored. 'PRI-1' will be displayed briefly.

To Store Priority Channel 2

1. Select the required channel.
2. Press **F** then immediately press and hold the **PRI 2** key. The channel number will flash then a high

beep will be heard as the channel is stored.
'PRI-2' will be displayed briefly.

To Recall Priority Channel 1

1. Briefly press the **PRI 1** key. The radio will immediately switch to the Priority 1 channel and 'PRI-1' will be displayed briefly.

To Recall Priority Channel 2

1. Press **F** then briefly press the **PRI 2** key. The radio will immediately switch to the Priority 2 channel and 'PRI-2' will be displayed for a few seconds.

NOTE: If the radio was scanning when either of the Priority channels were selected, the scan will be cancelled.

SCANNING

Overview

Your radio incorporates a Scan function that allows groups of user programmable channels to be scanned for signals. Channels can be scanned at a rate of 40 channels per second. When a signal is found, scanning will pause to allow the signal to be heard then resume scanning when the channel is clear again.

Scan Groups

The TX4500S features three scan groups - Open Scan, Group Scan and Network Scan. Each scan group has a separate channel memory allowing you to program your choice of channels into each group for scanning.

To cycle between Open Scan, Group Scan or Network Scan, briefly press the **MENU** key followed by the **OS/GS** key. 'OPEN', 'GROUP' or 'NETWK' will be displayed briefly.

NOTE: Network scan is disabled by default and if required, will need to be enabled through the menu.

Quick Select

To quickly determine which channels are currently programmed into the selected scan group.

1. Briefly press the **F** key. 'F' will be displayed
2. Rotate the channel control to step through the channels. Only channels that have been stored into the memory of the selected scan group will be displayed.

When finished, press the **F** key to exit.

Auto Skip

While scanning, if an active channel in your scan group becomes a nuisance by constantly interrupting the scan, briefly press the **SKIP** key on the microphone. The radio will temporarily remove the busy channel from the scan group for 30 seconds to allow time for the channel to become clear again. Scanning will then continue from the next channel in the sequence. After 30 seconds the skipped channel will be reinstated in the scan sequence.

If the unwanted active channel continues to interrupt the scan even after the 30 second skip period has elapsed, hold the **SCAN** key while the radio is paused on that channel. The 'nuisance' channel will be completely removed from the scan group for the duration of that scan session. To restore the channel, simply stop and restart the scan session using the **SCAN** key (or switch the radio Off then On again).

NOTE: You can skip as many busy channels from the scan group as you wish, however if you attempt to skip the last remaining channel, all the previously skipped channels will be restored to the scan group.

OPEN SCAN

Open Scan allows a group of channels to be scanned in an ascending sequence. If a signal is found, the scan will pause on that channel. During this time you can press the **PTT** switch on the microphone and talk on the channel. Once the channel has been clear for 5 seconds the scan will resume.

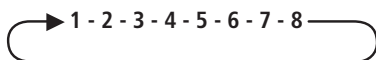



Selecting Open Scan

Briefly press the **F** key followed by the **OS/GS** key until 'OPEN' is displayed briefly.



Programming the Scan Memory

Your radio has all 80 channels factory-programmed into the Open Scan memory. Any channels not required can be removed.

To Add or Remove Channels from the Open Scan Memory

1. Select the required channel using the channel control.
2. Check to see if the Scan symbol  is displayed on that channel.
 - a. If  is displayed, the selected channel is already in the Scan memory. Press and hold the

SCAN key to remove it.  will disappear.

- b. If  is not displayed, the selected channel is not in the Scan memory. Press and hold the **SCAN** key to add the selected channel to the Scan memory.  will now be displayed on that channel.

Repeat to add or remove other channels in the scan memory.

Default Working Channel in Open Scan Mode

In the Open Scan mode, your default working channel is the channel your radio switches to when you press the **PTT** while scanning. To define your working channel simply select the required channel before you press the **SCAN** key. e.g. to make channel 24 your working channel, simply select channel 24 before pressing the **SCAN** key.

To talk on your working channel while scanning, simply press the **PTT**. The scan will pause and your radio will switch to your working channel allowing you to transmit and receive on that channel. Once your communication has finished and the channel has been clear for 5 seconds, scanning will resume.

If your radio pauses on a busy channel (other than your working channel) and you wish to talk on that channel, simply press the **PTT** during a break in the conversation. The busy channel now becomes your new working channel, replacing your previous working channel. Once your communication has finished and the channel has been clear for 5 seconds, scanning will resume.

To Begin Scanning

Briefly press the **SCAN** key. A high beep will be heard and the  icon will animate. During this time the channel numbers will change rapidly as the channels are scanned and the display will show 'OS-XX' where 'XX' is your working channel.

NOTE: If there are less than 2 channels programmed into the Open Scan memory, a long low beep will be heard when you press the **SCAN** key and the command will be ignored.

Operating in the Open Scan Mode

If a busy channel is located, scanning will pause to allow the signal to be heard and will remain there for as long as the channel remains busy. Once the channel has been clear for 5 seconds, scanning will resume automatically.

If you don't wish to listen to a busy channel, briefly press the **SKIP** key on the microphone to skip over that channel and resume scanning from the next channel in the sequence (see Auto Skip on page 10).

If you press the **PTT** while the radio is scanning, the scan will pause and the radio will transmit on the working channel. After the channel has remained been clear for 5 seconds scanning will resume.

If you press the **PTT** while the radio is paused on a busy channel, it will transmit on the busy channel and that channel will then become the new working channel. After the channel has remained clear for 5 seconds scanning will resume and 'OS-XX' on the display will be updated to show the new working channel.

If you need to use your Priority channel (for an urgent call), briefly press the **PRI 1** key at any time. The scan will be cancelled and the radio will jump straight to the Priority channel.

GROUP SCAN



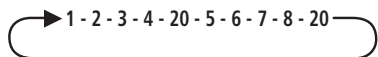

Group Scan allows you to scan a number of channels for activity while also monitoring your Priority channel. The receiver will scan the other channels ONLY WHILE THERE ARE NO SIGNALS ON THE PRIORITY CHANNEL. If a signal appears on the priority channel it will override any signals being received on any of the other channels. In addition, if you press the **PTT** switch at any time, the radio will transmit on the priority channel.



Selecting Group Scan

Briefly press the **F** key followed by the **OS/GS** key until 'GROUP' is displayed briefly.

Programming the Scan Memory

1. Select the required channel using the channel control.
2. Check to see if the Scan symbol  is displayed on that channel.
 - a. If  is displayed, the selected channel is already in the Scan memory. Press and hold the **SCAN** key to remove it.  will disappear.
 - b. If  is not displayed, the selected channel is not in the Scan memory. Press and hold the **SCAN** key to add the selected channel to the Scan memory.  will now be displayed on that channel.

Repeat to add or remove other channels in the scan memory.

Select your Priority channel

Program your Priority channels as described earlier under 'Priority Channel' then select which of the two Priority channels you wish to use for this Group Scan session. You must select your preferred Priority channel prior to scanning.

- Press the **PRI 1/PRI 2** key to use Priority channel 1.
- Press **F** then the **PRI 1/PRI 2** key to use Priority channel 2.

To Begin Scanning

Press the **SCAN** key. A high beep will be heard and the  icon will animate. During this time the channel numbers will change rapidly as the channels are scanned with the Priority channel will be scanned every fourth channel. During this time the display will show 'GS-XX' where 'XX' is your selected Priority channel.

If a signal appears on the Priority channel – at any time – the radio will switch directly to the Priority channel. The radio will now stay on the Priority channel for as long as the channel remains busy. During this time you can transmit and receive on the Priority channel. Once the Priority channel has been clear for 5 seconds the radio will resume scanning the other channels.

If a signal appears on any other channel, scanning will pause on that channel and will remain there while the channel is busy – as long as there are no signals on the Priority channel. During this time, the receiver will continue to check the Priority channel every 2 seconds resulting in a series of small breaks in the reception of the busy channel. Once the signal has gone and there has been no activity on any channel for 5 seconds, the radio will resume scanning.

To transmit on the Priority channel at any time, simply press the **PTT**. The radio will switch straight to the Priority channel. When you have finished your conversation and there has been no further activity for 5 seconds, the radio will resume scanning the other channels.

If the scan pauses on a busy channel and you don't wish to listen to that conversation, press the **SKIP** key on the microphone to temporarily skip that channel and resume scanning (see Auto Skip on page 10).

If the radio is paused on a busy channel and you want to remain there, briefly press the **SCAN** key. The radio will exit Scan and remain on the busy channel. At this point you will no longer be monitoring the Priority channel.

To resume Group scanning press the **SCAN** key again.

ADDITIONAL OPEN/GROUP SCAN OPTIONS

By default your radio has one Open Scan mode and one Group Scan mode. There may be applications where you have no need to monitor a Priority channel and would prefer to have two separate Open Scan modes.

Alternately you may prefer to have two separate Group Scan modes with different Scan channels in each. Your radio can be programmed to convert the Group Scan into an Open Scan and vice versa. If this is required, please contact your GME retailer to arrange for this feature to be activated.

When two Open Scan or two Group Scan modes are enabled, the Scan Group selection screen will display Open1 and Open2 for the Open Scan groups or GRP1 and GRP2 for the Group Scan groups. See the section 'Scanning' on page 10.

NOTE: Enabling or disabling a second Open or Group Scan mode is not a user selectable option. Once enabled or disabled, the new Scan mode becomes a permanent part of your radio's features. If you decide later that you need the original Scan mode settings restored you will need to return your radio to your GME retailer for re-programming.

NETWORK SCAN (NET-SCAN)

Net-Scan allows a group of radio users to maintain communications even when the band is congested. To achieve this all members of the Net-Scan group must share a common CTCSS/DCS code and a common set of scan channels.

Once activated, Net-Scan's intelligent scanning software keeps track of clear channels within your scan group. When any member of the group transmits, their radio automatically selects a clear channel to transmit on. Other radios scanning in the same Net-scan group will lock onto that channel allowing all members of the group to join the conversation. If a signal from outside your Net-Scan group appears on the chosen channel (either with no code or the wrong code), the group will automatically switch to a new clear channel at

the next transmission. In this way the group can continue to communicate with minimal interference to or from other users.

Enabling Net-Scan

Net-Scan is normally switched off by default but can be enabled through your radio's menu.

NOTE: When you enable Net-Scan you will also be prompted to choose a suitable CTCSS or DCS tone to be used by your Net-Scan group. All members of your Net-Scan group must use this same code.

To Enable Net-Scan

1. Hold the **MENU** key until the radio beeps. The radio will enter the menu mode.
2. Briefly press the **MENU** key repeatedly until 'NS-OF' is displayed.
3. Rotate the **Channel** control clockwise to enable Net-Scan then continue rotating to select a suitable CTCSS or DCS tone.
 - CTCSS tones for Net-Scan are labelled NS-01 – NS-50.
 - DCS tones for Net-Scan are labelled NS001 – NS104.



e.g. Netscan CTCSS tone 50 e.g. Netscan DCS tone 104

4. When the required CTCSS/DCS tone is displayed, press the **PTT** to exit.

Selecting Net-Scan

When Net-Scan is enabled, a new Network scan option becomes available on the **OS/GS** key. To select the Network Scan option, press the **MENU** key followed by the **OS/GS** key to cycle through the available scan groups until 'NETWK' is displayed. The radio is now in the Network Scan mode.

Programming channels into Net-Scan.

All radios in your Net-Scan group must have the same channels programmed into their Net-Scan memory. Your radio's Net-Scan memory has already been factory programmed with 43 of the available 80 channels. The remaining 37 channels, which consist of the 32 repeater input/output channels, 2 telemetry channels and 3 guard-band channels, have not been included to minimise the risk of interference to other services on these channels.





To quickly determine which channels are currently programmed into the Net-Scan group

1. With the **NETWORK** scan group selected, briefly press the **MENU** key. 'F' will be displayed
2. Rotate the **Channel** control to step through the channels. Only channels that are stored in the Net-Scan memory will be displayed. Take a note of the channel numbers to compare with the other radios in your Net-Scan group.

When finished, press the **MENU** key to exit.

To Add or Remove Net-Scan Channels

With Net-Scan mode enabled, select the require channel using the **Channel** control.

- If the channel is currently in the Net-Scan group the  icon will be visible above the channel display. To remove the channel, hold the **SCAN** key until a low beep is heard.  will disappear indicating the channel is no longer in memory.
- If the  icon is not visible above the channel display, the selected channel is not in the Net-Scan memory. To add it, hold the **SCAN** key until a high beep is heard.  will appear to confirm the channel is now in memory.

Repeat to add or remove further Net-Scan channels.

IMPORTANT: When adding channels to Net-Scan, please consider the following:

- The transmitter on your radio is inhibited on channels 22, 23 and channels 61, 62, 63 as required by the ACMA. This makes these channels unsuitable for use as Net-Scan channels.
- You should not include any repeater channels unless you have confirmed that the channel is not allocated to a repeater in your area. If you add an active repeater channel into your Net-Scan, you or others in your Net-Scan group may cause interference to other repeater users on that channel.

Starting Net-Scan

With Net-Scan mode enabled, press **SCAN**. The radio will begin scanning and 'NSxxx' (where xxx is the selected CTCSS or DCS tone) will be displayed.

Using Net-Scan

When a member of the group initiates a transmission their radio will automatically select a clear channel to transmit on. Other radios scanning in the same

Net-Scan group will locate the transmission by identifying the group's CTCSS/DCS code and open their Squelch allowing the transmission to be heard across the entire group. When the transmission ends, all radios in the group will immediately resume scanning.

If a member of the group responds to the initial transmission, they will automatically re-use the same channel as long as the channel remains free of other signals. This allows the radios in the group to respond more quickly to further transmissions from others in the group.

If at any time, a signal from outside your Net-Scan group appears on the channel (either with no code or the wrong code), the channel will be discarded and a new clear channel will be selected at the next transmission. The other radios in the group will then locate the new channel allowing the conversation to continue seamlessly without any input from the user.

Ending the Scan

To stop scanning, briefly press the **SCAN** key. A low beep will be heard and the animated  icon will stop. As long as the radio was not on a busy channel, it will return to the last channel you selected, otherwise it will stay on the busy channel.

USING THE PRIORITY CHANNEL WHILE SCANNING

- If your radio is scanning in Open Scan or Net-Scan mode and you need to use your Priority channel (for an urgent call or an emergency), briefly press the **PRI 1** key. The scan will be cancelled and the radio will jump straight to the Priority 1 channel. When your conversation has finished, press the **SCAN** key to continue scanning.
- If your radio is scanning in Group Scan mode simply press the **PTT**. The radio will automatically transmit on the Priority 1 channel. When your conversation has finished, the radio will resume scanning 5 seconds after the channel has become clear.

CTCSS & DCS

The standard Squelch system is fine for quieting the radio in most applications. However, it operates solely on signal strength which means that it will always open to any signal that is strong enough. If the channel is busy with other stations the Squelch will be constantly opening making it difficult to determine which calls are meant for you.

CTCSS/DCS provides selective audio muting using sub-audible signalling. When enabled, only signals with a matching sub-tone will be heard in the speaker. This effectively creates a channel that is silent to all traffic except those you wish to hear.

Choosing CTCSS or DCS

CTCSS uses a continuous analogue sub tone while DCS uses a digitally encoded sub tone. Choosing which tone system to use will largely depend on the other radios you talk with. If others already use CTCSS or DCS, you should select the tone system that matches theirs. If the users you talk to don't currently use CTCSS or DCS then you can make your own choice. There is no difference in performance or function between the different tone sets. Both types are included in the radio to maintain compatibility with other radio systems.

CTCSS Tone Set

The GME CTCSS tone set comprises a table of 50 tones made up of the standard CCIR-38 Tone Set plus an additional 12 tones added to the end. If communicating with other brands of radios that only use the CCIR-38 tone set, please select from one of the first 38 tones to ensure compatibility with these radios.

If communicating with other GME radios, you may choose from any of the 50 tones. However, please refer to the tone set tables listed in each radio's Instruction manual for compatibility because, although the same 50 tones are available in all GME radios, the tones used in older GME models may be listed in a different order to those in your radio.

DCS Tone Set

There are 104 DCS tones available (see the DCS tone chart at the rear of this manual).

To Select a CTCSS or DCS Tone

1. Press and hold the **MENU** key until the radio beeps. The CTCSS menu option will be displayed.
2. If 'CTCOF' is displayed, CTCSS/DCS tones are currently switched off (default). To enable CTCSS tones, rotate the **Channel** control to the right. CTCSS tones will be displayed as **CTC01 – CTC50**.
3. Continue rotating the **Channel** control to scroll past CTCSS tone 50 to access the DCS tones. DCS tones are displayed as **DT001 – DT104**.

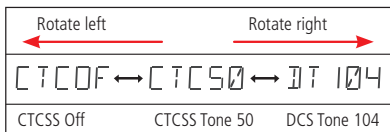

- To see the actual sub tone instead of the tone label, briefly press the **Channel** control. For CTCSS tones the tone frequency will be displayed in Hz. For DCS tones the Tone Code will be displayed. Press the **Channel** control again to return to the CTCSS/DCS label (refer to the CTCSS and DCS Tone Charts on page 28).



CTCSS Label

CTCSS Sub tone
Frequency

- To switch CTCSS/DCS tones Off, rotate the **Channel** control fully to the left until 'CTCOF' is displayed.

To exit the menu, briefly press the **PTT** or wait for the menu to time-out.

NOTE: The selected CTCSS/DCS tone will be used globally on any channels that have CTCSS enabled.

Enabling CTCSS/DCS on a Channel (Silent Mode)

Enabling CTCSS/DCS on a channel will prevent the Squelch from opening unless the incoming signal matches your selected CTCSS/DCS tone. Other users on the same channel who are not using your CTCSS/DCS tone will still be received by your radio (the icon will still appear on the display) – but their voice will not be heard in the speaker. Only when someone transmits on the channel using your CTCSS/DCS tone will the Squelch open to allow the signal to be heard. Channels where CTCSS/DCS have been enabled are said to be in 'Silent mode'.

NOTE: Silent Mode can be enabled on any channel except emergency channels 5 and 35.

To Enable Silent Mode on a Channel

- Select the required channel.
- Briefly press the **Silent** key. A high beep will be heard and an **S** icon (CTCSS) or **S** icon (DCS) will be displayed in the lower right of the display to indicate Silent mode is now enabled on that channel.

NOTE: You cannot enable Silent Mode unless a CTCSS or DCS tone has been selected in the Configuration menu. If CTCSS/DCS has been set to OFF, Silent mode is inhibited.

To Disable Silent Mode on a Channel

- Select the required channel. An **S** icon (CTCSS) or **S** icon (DCS) will be displayed indicating Silent mode is enabled.
- Briefly press and hold the **Silent** key. A low beep will be heard and the **S** (CTCSS) or **S** (DCS) icon will disappear to indicate Silent mode has been removed from that channel.

IMPORTANT: When Silent mode is enabled on a channel you should always check the icon for signs of traffic on the channel before transmitting to ensure you do not accidentally transmit over the top of another user. Alternatively, you can enable **Busy Lockout** in the **Configuration menu** which will automatically prevent your radio from transmitting if the channel is already in use.

Monitor Function

When the current channel is in Silent mode, the icon may appear but no sound will be heard in the speaker. This indicates that your radio is receiving a signal that does not match your CTCSS/DCS tone. If you wish, you can briefly monitor the channel as described below. This temporarily disables Silent mode, allowing the signal to be heard.

To monitor signals on the channel, press and hold the **Squelch** control. When you release the **Squelch** control, Silent mode is restored and the radio will become quiet again.

SELECTIVE CALLING

Overview

Your radio has a Selective Calling system known as SelCall that operates like a telephone. Your radio is pre-programmed with its own unique SelCall Identification number. If this number is called by another radio, your radio will beep to alert you. If you do not want to hear any other activity while waiting on a channel, you can select the Quiet mode. Your radio will then remain quiet to all incoming signals until your SelCall number is called.

Your radio will allow you to store up to ten of your most frequently called SelCall numbers in memory and each number can be labelled for easy identification.

SelCall Identification Number

Your radio is factory programmed with its own unique SelCall Identification Number (Ident). This number identifies your radio from others in your area. Your radio's own SelCall Ident will be displayed for a few seconds to the left of the channel display when you first turn the radio on. You will need to make your Ident known to anyone who may need to call you using SelCall.

NOTE: Although your radio is factory-programmed with a unique SelCall Ident, you can change your Ident to another number if required (see **SelCall Memories** further below).

SelCall Ident Labels

When storing SelCall Idents, you can add labels to each one to make it easier to identify whose Ident you are recalling. In addition, if an incoming SelCall matches one of your stored Idents, the label can be displayed instead of the Ident.

To add or display labels, your radio must be in the ALPHA mode. To switch between ALPHA mode and NUMERIC mode, briefly press the **F** key followed by the **ALPHA** key. 'ALPHA' or 'NUMBER' will be displayed briefly to the left of the channel display to indicate the selected mode.

The Quiet Mode

Your radio can be set to monitor signals on a busy channel but remain QUIET unless it receives its own SelCall Ident. In this way, you won't be disturbed unless someone calls you. When your SelCall Ident is received, the Quiet mode is deactivated and an alarm sounds to alert you to the call. You can then converse normally on the channel. To use the Quiet mode, refer to the Quiet mode section on next page.

NOTE: The Quiet mode overrides the normal Squelch system to ensure that the radio remains quiet even when the channel is busy. When QUIET is set, you may see the  icon appear on the display indicating the channel is being used. However, unless someone transmits your SelCall Ident, nothing will be heard in the speaker.

You can activate the Quiet Mode on individual channels i.e. some channels can be set to remain Quiet while others can remain open to all incoming signals.

USING SELCALL

Entering a SelCall Ident

1. Press the **CALL** button.  is displayed, along with the last sent or received SelCall Ident. If an ALPHA label is displayed you will need to press **F** then **ALPHA** to switch to Numeric mode.
2. Press and hold the **Channel** control until the radio beeps. The right-hand digit of the SelCall Ident will flash.
3. Rotate the **Channel** control to select the required number in the flashing digit position.
4. Briefly press the **Channel** control again to select the next digit position.
5. Repeat steps 4 and 5 to enter all 5 digits as required. The SelCall number is now ready to send.
6. Press and hold the **CALL** button. A long beep will be heard and the radio will transmit the SelCall Ident.

NOTE: If the call is not sent within 10 seconds of entering the last Ident digit the Call function will time-out and the radio will return to normal mode. To exit the  mode without sending the SelCall, briefly press the **CALL** button.

Call Acknowledge

If your SelCall transmission is successful, the radio you called should respond with an 'acknowledge' signal – usually two quick beeps. This will confirm to you that the radio you called is now alerting its user to your signal.

SelCall Memories

Your radio is fitted with one 'Call' memory and 10 user programmable SelCall memories labelled '**CO**' to '**C9**'. There is also one additional location labelled '**Id**'.

Memory locations '**CO**' to '**C9**' are for storing frequently called SelCall Idents. The additional location labelled '**Id**' contains your radio's own SelCall Ident. You should only select this memory location if you need to change your radio's factory programmed SelCall Ident.

To Store a SelCall Ident in Memory

1. Briefly press the **CALL** button.  is displayed along with the last sent or received SelCall Ident.
2. Rotate the **Channel** control clockwise to select the required Ident memory location '**CO**' to

- 'C9' (or select 'Id' to change your radios own SelCall Ident). If an ALPHA label is displayed you will need to press **F** then **ALPHA** to switch to Numeric mode.
- Press and hold the **Channel** control until the radio beeps. The right-hand digit of the SelCall Ident will flash.
 - Rotate the **Channel** control to select the required number in the flashing digit position.
 - Briefly press the **Channel** control again to select the next digit position.
 - Repeat steps 4 and 5 to enter all 5 digits as required.
 - Now press and hold the **Channel** control. The entire Ident will flash for a few seconds then the radio will beep as the new Ident is stored.
e.g. Programming Call Memory C5

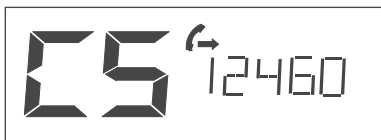

- If the ALPHA label is empty, '- - - -' will be displayed, otherwise it will display the last ALPHA label programmed into that memory.
- Press and hold the **Channel** control until the radio beeps. The left-hand position of the Alpha label will flash.
- Rotate the **Channel** control to select the required character in the flashing position then briefly press the **Channel** control again to select the next position.
- Repeat step 6 to enter up to 5 characters as required.
- Now press and hold the **Channel** control. The entire Alpha label will flash for a few seconds then the radio will beep as the label is stored.

e.g. Labelling Call Memory C5

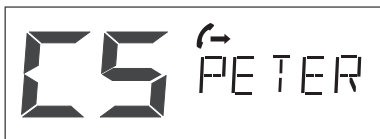

Recalling SelCall Idents

- Briefly press the **CALL** button. \rightarrow is displayed along with the last sent or received SelCall Ident.
- Rotate the **Channel** control to select the required Ident memory in locations 'C0' to 'C9'.
- Press and hold the **CALL** button to send the Ident.

Naming your SelCall Idents

Your radio allows you to label each SelCall Ident using a 5 character name to make it easier to identify callers. If an incoming SelCall matches one of those in your radio's memory, the label can be displayed instead of the SelCall Ident.

NOTE: Before adding an ALPHA label to a SelCall Ident, you must first store the required Ident in memory as described left.

- Briefly press the **CALL** button. \rightarrow will be displayed along with the last sent or received SelCall Ident.
- Rotate the **Channel** control to select the required Ident memory in locations 'C0' to 'C9'.
- Briefly press the **F** then **ALPHA** to select the ALPHA mode. **ALPHA** will be displayed briefly.

Repeat steps 2 to 8 to add ALPHA labels to any other SelCall Idents stored in memory. The following characters are available;

Letters	A B C D E F G H I J K L M N O P Q R S T U V W X Y Z
Numbers	0 1 2 3 4 5 6 7 8 9
Punctuation	<space> * +

To exit the CALL TO mode, briefly press the **CALL** button (or simply wait for the Call function to time out). The radio will return to normal operation.

To display the Alpha labels of incoming SelCalls, the radio should be left in Alpha mode. Any incoming SelCall that does not match those in the memory will display -NEW-. To display the SelCall Ident of that caller, briefly press **F** then **ALPHA** to return to the NUMERIC mode.

Receiving SelCalls

When your radio receives it's SelCall Ident, an alarm will sound to alert you to the call. Initially the alarm will beep urgently at 2 beeps per second, then, if the call is not answered, it will slow to around 1 beep every 3 seconds. It will then continue to beep indefinitely until you cancel it.

In addition to the alarm, the  symbol will appear on the display along with the callers SelCall Ident or ALPHA label to inform you of the caller's identity.



Incoming call showing SelCall Ident



Incoming call showing Alpha label

To Return the Call

Press and hold the **CALL** button for a few seconds until the radio beeps. The caller's SelCall will be sent back to the caller.

To Cancel the Alarm:

Briefly press the **PTT**. The alarm will be cancelled and the channel will be open for normal communication. You can now talk on the channel in the usual way.

QUIET MODE

The Quiet Mode mutes the receiver to prevent incoming signals from being heard in the speaker until your SelCall Ident is received. In this way you can monitor a busy channel for personal calls without being disturbed by unwanted signals. If your SelCall Ident is received, the Quiet mode is cancelled and all incoming signals are heard in the speaker.

Setting up the Quiet Mode

To setup the Quiet mode you must first 'tag' the channels that you want to stay Quiet, then activate the Quiet mode. Once the Quiet mode is activated, tagged channels will remain Quiet to all incoming signals unless your SelCall Ident is received. Channels not tagged will remain open to all signals and will operate normally.

To Tag Individual Channels for QUIET Operation

1. Select the required channel.
2. Briefly press **F** then press and hold **QUIET** until the radio beeps. 'Q' will appear on the lower right of the display channel number indicating

the selected channel is now tagged for Quiet operation.

To Remove the QUIET Tag from Individual Channels



1. Select a channel that has been tagged for Quiet operation. 'Q' will be displayed.
2. Briefly press **F** then hold **QUIET** until the radio beeps. 'Q' will disappear indicating this channel is no longer tagged for Quiet operation.

Activating the Quiet Mode

1. Select a channel that has been tagged for Quiet operation (you cannot activate the Quiet mode unless you have selected a 'tagged' channel). 'Q' will be displayed.
2. Briefly press **F** then press **QUIET**.  will appear on the display.

Now all channels that were tagged for Quiet operation will be operating in the Quiet mode.

De-activating the Quiet Mode

1. Select any channel that has been tagged for Quiet operation. 'Q' and  will be displayed.
2. Briefly press **F** then press **QUIET**.  will disappear from the display and all channels that were tagged for Quiet operation will now operate normally again.

Receiving Signals in the Quiet Mode

- If a normal signal is received on a QUIET channel, the channel will appear busy (the  icon will be visible) but no sound will be heard from the speaker.
- If a normal signal is received on an Open channel (one that is not tagged with 'Q') the signal will be heard in the usual way.
- If your SelCall Ident is received on any channel - Open or QUIET - the Quiet mode will be cancelled and the alarm will beep to alert you to the call. In addition, the caller's Ident or ALPHA label will be displayed. All channels will now be open for normal transmission and reception.

If you wish to respond to the caller using SelCall, press and hold the **CALL** button until the radio beeps. The caller's Ident will be transmitted back to them causing the alarm in their radio to be activated.

To cancel the alarm on your radio, briefly press the **PTT**.

To return your radio to the Quiet mode, briefly press **F** then press **QUIET**. **Q** will re-appear on the display.

Scanning in the Quiet Mode

The radio will allow you to scan while the Quiet mode is active. Using this feature you can monitor a group of Quiet channels or a combination of Quiet and Open channels.

To Scan in the Quiet Mode

1. Pre-select the required OS or GS Scan group (briefly press **F** then **OS/GS**).
2. Program your Scan channels as described under the Scanning section.
3. From those channels, select the ones you wish to remain Quiet and tag each one for QUIET operation (press **F** then press and hold **QUIET**).
4. Select a tagged channel and activate the Quiet mode (briefly press **F** then press **QUIET**).
5. Press the **SCAN** key. The radio will begin scanning and 'SCAN' and **Q** will be displayed, indicating the radio is scanning in the Quiet mode.

Receiving Signals while Scanning in the Quiet Mode

- If a normal signal is received on an open channel, scanning will pause while the channel is busy and will resume scanning 5 seconds after the channel becomes clear. (If you were scanning in Group scan mode, the radio may switch between the open channel and the Priority channel - this is normal).
- If a normal signal is received on a Quiet channel but your SelCall Ident is not detected, the signal will be ignored and scanning will continue.
- If a signal containing your SelCall Ident is received on any channel - Open or Quiet - both scanning and Quiet modes will be cancelled and the receiver will stay on that channel. In addition, the alarm will beep to alert you to the call and the callers Ident or ALPHA label will be displayed. The channel will now be open for normal transmission and reception.

TIP: To ensure reliable SelCall detection when scanning in the Quiet mode, it is recommended that you restrict the number of channels in the Scan group to 4 or less.

GROUP CALLING

The SelCall system includes a Group call function which allows you to call up to 1000 radios simultaneously. This can be useful in an emergency situation where you may need to transmit a message to a large number of radios in your group.

By default, your radio is factory-set to allow up to 10 radios to be called at once. If your application requires more, you can arrange for your Dealer to re-program this option to allow 100 or 1000 radios to be called. The following description assumes the default Group call setting of 10 radios.

The Group call function works by allowing you to enter a special 'group code' into the last digit positions of the SelCall Ident you are sending. The 'group code' appears as an 'A' when displayed in the radio. When this 'group code' is received, it substitutes for all other numbers in that position. As long as the first 4 digits of the SelCall you are sending match those of the radios you are calling, their SelCall alarm will be activated as if their full 5 digit SelCall Idents had been received.

To achieve this, the 10 radios you are calling must be programmed with sequentially numbered SelCall Idents.

e.g. 14530, 14531, 14532, 14533 . . .-> , 14539

- Transmitting the SelCall Ident 14531 will only activate the alarm in the radio with the SelCall Ident of 14531.
- Transmitting 1453A will activate the alarms in all radios with Idents 14530 through 14539 (a total of 10 radios).

If the radios in your fleet do not have sequentially numbered SelCall Idents and you want to make use of this function, you will need to re-program the SelCall Idents in your radios.

Programming and sending Group calls

The process for entering a Group call Ident is the same as entering a normal SelCall Ident.

1. Press the **CALL** button. **↔** is displayed, along with the last sent or received SelCall Ident. If an ALPHA label is displayed you will need to press **F** then **ALPHA** to switch to Numeric mode.
2. Press and hold the **Channel** control until the radio beeps. The right-hand digit of the SelCall Ident will flash.

3. Rotate the **Channel** control to select 'A' in the flashing digit position. This is the special code that will create the Group Call.
4. Briefly press the **Channel** control again to select the next digit position.
5. Continue entering the other 4 digits as required. The SelCall number is now ready to send.
6. Press and hold the **CALL** key. A long beep will be heard and the radio will transmit the SelCall Ident.

NOTE: Where your radio allows it, programming group calls for 100 radios is identical except that you will need to select 'A' for the last two digits (e.g. 123AA). For 1000 radios you will need to select 'A' for last three digits (e.g. 12AAA).

e.g.

Sending Ident 145AA will call 100 radios with Idents 14500 -> 14599

Sending Ident 14AAA will call 1000 radios with Idents 14000 -> 14999

You can also arrange to send SelCalls to every tenth radio by setting the second digit to A.

e.g.

Sending Ident 145A5 will call radios 14505, 14515, 14525, 14535, 14545 . . -> 14595

Call Acknowledge in Group Mode

There is no call acknowledge when sending group calls. This is to prevent all the radios in your group from trying to respond to your SelCall transmission at the same time.

Storing Group Call Idents

Group call Idents can be stored in memory in the same way as a standard SelCall Ident.

Receiving Group Calls

Receiving a Group call is identical to receiving a normal SelCall except that the alarm sound is a LOW tone beep instead of the normal High tone beep. The caller's Ident or ALPHA label appears on the display in the usual way.

RECEIVE-ONLY CHANNELS

The TX4500S supports up to 95 user programmable Receive-only channels with frequencies in the range 403 – 520 MHz. Frequencies can be stored in five separate channel banks labelled A to E, each containing up to 19 channels. These additional 19 channels are located directly above CB channel 80 (81 – 99).

Each Receive-only channel can also be assigned an Alpha label to help identify that channel when it is selected.

Frequency programming and channel bank selections are accessed through the configuration menu.

Selecting Channel Banks

Before programming or recalling channels you should select the required channel bank. The 5 channel banks can be enabled through the menu either as individual banks of 19 channels (RX-A, RX-B, RX-C, RX-D or RX-E) or as a combined group of 95 channels (RXA-E).

The default channel bank is RX-A.

Separate Channel Banks

	RX-A	RX-B	RX-C	RX-D	RX-E
R X O N L Y C H A N N E L S	81	81	81	81	81
	82	82	82	82	82
	83	83	83	83	83
	84	84	84	84	84
	85	85	85	85	85
	86	86	86	86	86
	87	87	87	87	87
	88	88	88	88	88
	89	89	89	89	89
	90	90	90	90	90
	91	91	91	91	91
	92	92	92	92	92
	93	93	93	93	93
	94	94	94	94	94
	95	95	95	95	95
	96	96	96	96	96
	97	97	97	97	97
	98	98	98	98	98
	99	99	99	99	99

Combined Channel Banks RXA-E

	RX-A	RX-B	RX-C	RX-D	RX-E
R X O N L Y C H A N N E L S	81	81	81	81	81
	82	82	82	82	82
	83	83	83	83	83
	84	84	84	84	84
	85	85	85	85	85
	86	86	86	86	86
	87	87	87	87	87
	88	88	88	88	88
	89	89	89	89	89
	90	90	90	90	90
	91	91	91	91	91
	92	92	92	92	92
	93	93	93	93	93
	94	94	94	94	94
	95	95	95	95	95
	96	96	96	96	96
	97	97	97	97	97
	98	98	98	98	98
	99	99	99	99	99

To Select a Channel Bank

1. Press and hold the **MENU** key. A high beep will be heard and the radio will enter the configuration menu.
2. Briefly press the **MENU** key repeatedly until the **RX-** channel bank option is displayed.
3. Rotate the **Channel** control to select individual channel banks **RX-A** through **RX-E**. Select **RXA-E** to enable all channel banks as a combined group of 95 channels.
4. When finished, press the **PTT** to exit the menu.

Programming RX-only Channel Frequencies

RX-only channels are switched off by default. To program RX-only channels you will need to activate the channel editor which will then allow access to channels 81-99 in the currently selected channel bank. RX-only channels can be programmed with frequencies in the range 403 – 520 MHz.

To program RX-only frequencies, your radio must be in Numeric mode. If your radio is in Alpha mode briefly press **F - ALPHA** so that 'NUMER' is displayed

To Activate the Channel Editor

1. Switch the radio OFF.
2. Press and hold the **Channel** control while switching the radio ON again.
3. **RXALL** will be displayed briefly, indicating the RX Channel Editor has been activated.

You can now rotate the **Channel** control past channel 80 to select additional channels 81-99. **-OFF-** will be displayed to the right of the channel numbers indicating that these channels are switched OFF and do not yet contain any frequencies.

Selecting Frequency Steps

NOTE: This menu option is only available when RX-only channels are selected.

The frequency step is the spacing between frequencies when the **Channel** control is rotated. The frequency step can be set to either 12.5 kHz or 25 kHz. The default is 25 kHz. You should select a frequency step that matches the channel allocations in the frequency band you are programming. When selecting 25 kHz or 12.5 kHz steps, the appropriate wideband or narrow band filter is automatically selected to ensure optimum performance.

1. Press and hold **MENU** until the radio beeps.
2. Briefly press **MENU** repeatedly until the frequency step is displayed.

25,0K 12,5K

25 kHz Steps

12.5 kHz Steps

3. Rotate the **Channel** control left or right to change the frequency step.
4. Press the **PTT** to exit the menu.

To Program an RX-only Frequency

1. Rotate the **Channel** control to select a suitable channel number (81-99). **-OFF-** will be displayed to the right of the channel number.
2. Press and hold the **MENU** key until the radio beeps. **'-OFF-'** will flash. You now have 6 seconds to begin programming otherwise the menu will time-out.
3. Rotate the **Channel** control to the right to begin selecting your desired frequency starting at 403 MHz. Continue to rotate to the right to increase

the frequency or to the left to decrease the frequency. The display will show the frequency to the nearest 10 kHz.

e.g. 468.425 will display as:

Display	Frequency
46840	468.4000
46841	468.4125
46842	468.4250
46843	468.4375
46845	468.4500
46846	468.4625
46847	468.4750
46848	468.4875
46850	468.5000

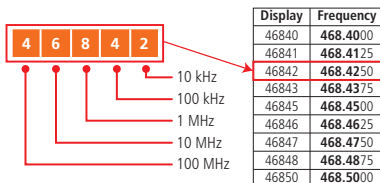

- To advance through the frequencies more quickly, briefly press the **Channel** control. The frequency will now adjust in 1 MHz steps. As you approach the desired frequency, briefly press the **Channel** control again to return the original 25 kHz/12.5 kHz steps.
- Once your desired frequency is displayed, press and hold the **Channel** control until the radio beeps. The frequency is now stored under your selected channel number.



e.g. 458.325 MHz stored under CH 90

- Repeat steps 1 – 5 to program other channels.

NOTE: The frequency tuning is live which means the radio is actually listening to the frequencies you are selecting. You can use this feature to locate and store active frequencies while you are tuning.

To program more than 19 channels, you will need to switch to another channel bank. Simply press the **MENU** key repeatedly until the **RX-** Channel Bank option appears then select another Channel Bank. Once selected, press the **MENU** key repeatedly to return to the frequency programming option and continue programming your preferred frequencies.

To Close the Channel Editor

Switch the radio OFF then ON again to close the channel editor and restore normal operation. Your programmed frequencies will now be accessible from the **Channel** control above CH80. Remember, if you have stored channels into different channel banks, you will need to select the appropriate channel bank to access them.

NOTE: Under normal operation, only those channels that have been programmed with frequencies will be visible. Channels that were marked with **–OFF–** in the channel editor will no longer be visible.

Deleting an RX-only Channel

To delete an RX-only channel;

- Enable the Channel Editor.
- Select the channel you wish to delete.
- Press and hold the **MENU** key until the radio beeps.
- Rotate the **Channel** control all the way to the left until **–OFF–** is displayed.
- Press and hold the **Channel** control to store the new setting.
- Switch the radio OFF then ON again to restore normal operation.

The deleted channel will no longer be visible.

Displaying the RX-only Channel's Frequency or Alpha Label

By default the radio displays the Signal Strength meter to the right of the channel number. You can configure the display to show the Frequency or the Alpha name of the selected channel.

Before starting, ensure the radio is in the Numeric mode (press **F** then **ALPHA** so that 'NUMER' is displayed).

- Select an RX-only channel (the following menu option is only available when an RX-only channel is selected).
- Press and hold **MENU** until the radio beeps.
- Briefly press **MENU** repeatedly until **S-MET** appears.
- Rotate the **Channel** control to the right until 'ALPHA' is displayed.
- Press the **PTT** to exit the menu.

The radio will now display the channel frequency to the right of the channel number whenever an RX-only channel is selected.

To Display the Channel's ALPHA Label

Briefly press **F** then **ALPHA**. 'ALPHA' will appear briefly then the channel's Alpha label will be displayed to the left of the channel number. If the Alpha label is blank, then an Alpha label has not yet been set for this channel. Use the following steps to enter your preferred Alpha label.

Adding Names to Your RX-only Channels

NOTE: You do not need to activate the channel editor to make changes to RX-only channels that have already been programmed.

1. Select an RX-only channel. The channel frequency will be displayed to the left of the channel number.
2. Press **F** then **ALPHA** to switch to Alpha mode. 'ALPHA' will be displayed briefly.
3. Press and hold the **MENU** key until the radio beeps. The cursor will flash in the left character position.
4. Rotate the **Channel** control to select the required character. Press the **Channel** control to advance to the next character position.
5. When the desired name is displayed, press and hold the **Channel** control to store the name.
6. Briefly press the **PTT** to exit and return to normal operation.



RX-only channel frequency (458.325 MHz)



RX-only channel label (CAR-4)

When viewing RX-only channels, briefly press **F** then **ALPHA** at any time to toggle between the channel frequency and the Alpha name.

CONFIGURATION MENU

The configuration menu provides access to preset functions within the radio.

To access the menu press and hold the **MENU** key until a beep is heard. Selected menu options are displayed to the right of the channel display. Briefly press the **MENU** key to step through the available menu options. Rotate the **Channel** control to change the selected menu option. After viewing or

making changes, briefly press the **PTT** to exit the menu (or simply wait for the menu to time-out).

The following settings are available.

Menu Option	CB	RX-only
RX-only Frequency / Label editing	NA	Frequency, Alpha Label
CTCSS	CTCOF (CTCSS OFF) CTC01 to CTC50 (CTCSS Tones) DT001 to DT104 (DCS Tones)	
Network Scan	NS-OFF (Netscan OFF) NS-01 to NS-50 (Netscan On Using CTCSS) NS001 to NS104 (Netscan On Using DCS)	
Voice Scrambler	ENCOF (Scrambler OFF) ENCON (Scrambler ON)	
Silent Squelch Tail	SSTOF (Silent Squelch Tail OFF) SSTON (Silent Squelch Tail ON)	
Key Beep Tone Level	BEEP 0 to BEEP 9	
RX-only Frequency Step	NA	12.5K, 25.0K
Filter Bandwidth	WBFLT (Wideband Filter) NBFLT (Narrowband Filter)	NA
Dynamic Volume Control	DVCOF (Dynamic Volume Control OFF) DVCON (Dynamic Volume Control ON)	
Display Mode Options	S-MET (S-Meter Log) S-LIN (S-Meter Linear) BATT (Battery Volts)	S-MET (S-Meter Log) S-LIN (S-Meter Linear) BATT (Battery Volts) ALPHA Labels
Busy Lockout	BLKOF (Busy Lockout OFF) BLKON (Busy Lockout ON)	
RX-only Channel Banks	RX-A, RX-B, RX-C, RX-D or RX-E (5 x 19 channels) RXA-E (95 Continuous Channels)	

Frequency/ Alpha Label

(only available on receive-only channels)

Allows editing of the channel frequency or Alpha label of the selected receive-only channel.



Frequency 458.325 MHz



Alpha label "FIRE 1"

CTCSS/ DCS Tone Selection

Enables and selects CTCSS or DCS tones. To switch CTCSS or DCS tones OFF rotate the **Channel** control fully to the left until 'CTCOF' is displayed.



Network Scan

Enables the Network Scan function in the OS/GS menu and selects a suitable CTCSS/DCS code for use with Network Scan.

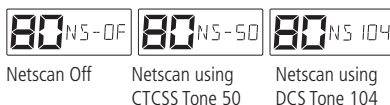

Voice Scrambler

Enables or disables the Voice Scrambler.



Silent Squelch Tail (SST)

Enabling the 'Silent Squelch Tail' function removes the Squelch Tail - the short noise burst normally audible when the Squelch closes. Disabling the 'Silent Squelch Tail' function restores the Squelch Tail.



Beep Tone Level

Adjusts the volume level of the beep tones associated with key presses.



Frequency Step Selection

(only available on receive-only channels)

Sets the frequency spacing of receive-only channels to 12.5 kHz or 25 kHz (default).



NOTE: This option does not affect the standard 80 CB channel spacing.

Filter Bandwidth

(only available on CB channels)

Selects the receiver bandwidth filter on channels 1 – 40.



Dynamic Volume Control (DVC)

When enabled, automatically compensates for variations in received audio level to provide a constant audio output level to the speaker.

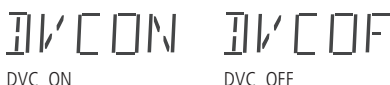

Display Mode Options

The display can be configured to show several different options in the lower left of the display when receiving.

- **S-MET:** Shows received signal strengths in standard digital format from 0 (no signal) to 9+ (very strong signal).
- **S-LIN:** Shows received signal strengths with extended resolution from 0 (no signal) to approximately 63 (very strong signal). A change of 1 digit in this mode corresponds to around a 10% change in signal strength.
- **BATT:** Displays the battery voltage.
- **ALPHA:** (only available on receive-only channels): In Numeric mode, displays the frequency of the selected RX-only channel. In Alpha mode displays the Alpha label associated with the selected RX-only channel.

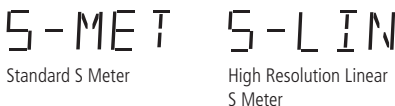

BATT

Battery Voltage

ALPHARX-only Channel
frequency or Alpha name

Busy Lockout

Busy Lockout prevents your radio from transmitting if the channel is busy. If the PTT is pressed while the channel is busy, a beep tone will be heard and the radio will not transmit.

BLK OF

Busy Lockout Off

BLK ON

Busy Lockout On

Channel Banks

Selects the current receive-only channel bank. The receive-only channel memory consists of 5 banks of 19 channels. Channel banks are labelled **RX-A** to **RX-E**. To enable all channel banks as a combined group of 95 channels, select RXA-E.

RX-D

CH Bank D

RX-E

CH Bank E

RXA-E

All Banks

RX-A

CH Bank A

RX-B

CH Bank B

RX-C

CH Bank C

INSTALLATION

Your TX4500S is supplied with a DIN mounting bracket for mounting into a standard DIN sized cavity in the vehicle's console or dashboard. Before installing the radio, ensure the DC cable and antenna have been installed correctly (as described on following pages) and the connectors are accessible through the DIN cavity.

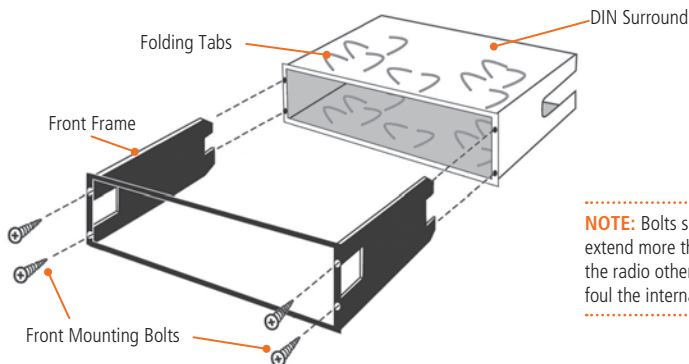

Installing the DIN Bracket

1. Remove the four small front mounting screws from the front edges of the DIN mount and separate the front frame from the DIN surround.
2. Slide the DIN surround into the DIN slot in the vehicle's console and secure it in the desired position by bending the folding tabs.
3. Slide the radio into the front frame from the front until the threaded holes in the radio chassis line up with the holes in the DIN frame.

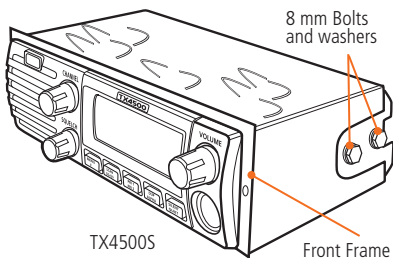

4. Secure the radio using the four 8mm bolts supplied.

NOTE: Bolts should not extend more than 6mm inside the radio otherwise they may come into contact with the internal components.

5. Feed the antenna connector and DC lead through the DIN slot in the dashboard and connect these to the matching sockets on the radio.
6. Slide the radio and front frame assembly into the DIN surround and secure it using the four small front mounting screws.

NOTE: Bolts should not extend more than 6 mm inside the radio otherwise they may foul the internal components.

DC POWER CONNECTION

The TX4500S is designed for 13.8 V DC negative earth installations only (i.e. where the negative side of the battery is connected to the frame or chassis of the vehicle). There are two recommended methods of installation. Please refer to the following diagrams.

Radio Remains On when the Ignition Switch is Off

Connect the radio's negative (Black) lead to the vehicle's chassis or if preferred directly to the battery's negative terminal.

Connect the radio's positive (Red) lead, via the 2 Amp fuse, to the battery's positive terminal or to a point in the fuse box that has +13.8 volts continuously available.

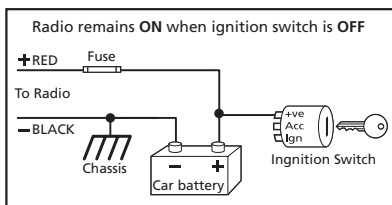

The radio can now be switched On or Off at any time using the switch on the **Volume** control.

Radio Turns On and Off with the Ignition Switch

Connect the radio's negative (Black) lead to the vehicle's chassis or if preferred directly to the battery's negative terminal.

Connect the radio's positive (Red) lead, via the 2 amp fuse, to the accessory point in the fuse box. This point should supply +13.8 volts ONLY when the ignition is switched ON or in the ACCESSORY position.

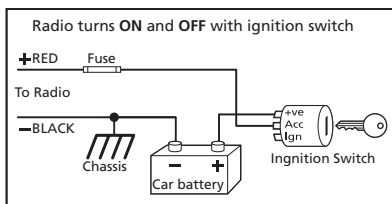

The radio should now switch ON and OFF automatically with the vehicle's ignition switch.

MICROPHONE

The TX4500S is fitted with two microphone sockets – one on the front panel and one on the rear. The 6 pin microphone connector can be plugged into either socket. In fact, if the situation requires it, two microphones can be connected simultaneously. The first microphone keyed takes priority.

Front

The front microphone socket is fitted with a hard protective cover. The cover is a press fit. To remove the cover, insert a paper clip or similar into the small slot in the edge of the cover and lift the cover away from the panel. Retain the cover in case you require it later on.

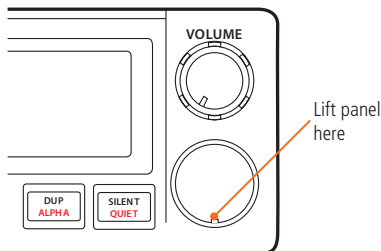

Position the microphone plug so the plastic tab faces upwards then press the plug into the socket until it 'clicks'.

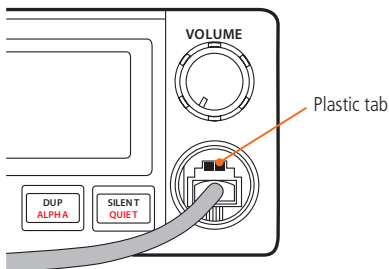

Gently press the rubber strain relief grommet into the hole surrounding the socket so that the slot around the grommet fits neatly inside the lip inside the hole.

Rear

If using the rear microphone connection you should obtain the optional LEM6P rear microphone extension lead. Mount the socket on a convenient location and feed the plug through the dashboard to the DIN cavity.

The rear microphone cover hinges from the top. Simply lift the cover from the bottom. The cover will remain connected to the chassis.

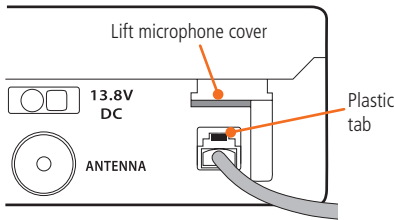

Position the microphone plug so the plastic tab faces upwards then press the plug into the socket until it 'clicks'.

Removing the Microphone

For front panel connections, first squeeze the grommet to disengage it from the slot then slide it along the microphone cord.

For both connections, squeeze the microphone plug's plastic tab towards the plug to unlock it while gently pulling on the microphone cable. The plug should release from the socket. If the plug does not come out easily, the tab has not been release fully – squeeze the tab again.

ANTENNA INSTALLATION

It is essential to install a good quality, high efficiency, 477 MHz antenna. A poor quality antenna or one not designed for the specific frequency band will give very poor performance.

GME have a huge range of suitable 477 MHz antennas to suit most installations and applications. We recommend you contact your local retailer for advice.

After mounting the antenna, feed the antenna cable to the DIN cavity in the vehicles console or dashboard before mounting the radio.

High Voltage Detection

The radio has a built-in, high voltage detection system to warn you if an overvoltage situation occurs. If the power supply voltage exceeds 18 volts DC, the channel display will flash 'hi dc' for 5 seconds when the unit is first turned on, or at the time the voltage exceeds 18 volts. In addition, when transmitting, the TX indicator will flash and the transmitter will select low output power.

If the overvoltage warning appears you should switch your radio OFF and disconnect it from the

power source, before locating the cause of the trouble.

Once the 'High Voltage' warning has been triggered, and you have fixed the source of the problem, you will need to switch the radio OFF then ON again to reset it.

NOTE: The power source should never exceed 25 V.

WIRING

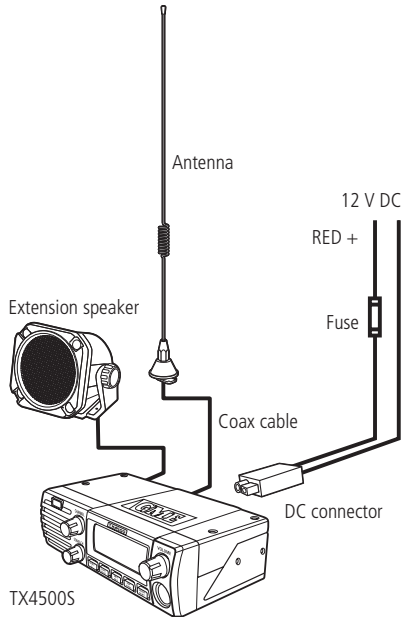

NOISE SUPPRESSION

The inherent design of FM transceivers results in a high level of resistance to ignition and electrical interference. However in some installations it may be necessary to take additional steps to help reduce or eliminate noise interference. During installation, try to route the DC battery leads, the antenna lead or any accessory wires away from the engine compartment, ignition or alternator wiring. If the noise continues, it may be necessary to fit a suppression kit in which case we recommend you consult an auto electrician for advice specific to your installation.

Higher frequency electrical interference cause by electric motors can be suppressed directly at the motor terminals.

CTCSS TONE FREQUENCIES CHART

No.	Frequency	No.	Frequency	No.	Frequency	No.	Frequency
1	67.0	14	107.2	27	167.9	40	159.8
2	71.9	15	110.9	28	173.8	41	165.5
3	74.4	16	114.8	29	179.9	42	171.3
4	77.0	17	118.8	30	186.2	43	177.3
5	79.7	18	123.0	31	192.8	44	183.5
6	82.5	19	127.3	32	203.5	45	189.9
7	85.4	20	131.8	33	210.7	46	196.6
8	88.5	21	136.5	34	218.1	47	199.5
9	91.5	22	141.3	35	225.7	48	206.5
10	94.8	23	146.2	36	233.6	49	229.1
11	97.4	24	151.4	37	241.8	50	254.1
12	100.0	25	156.7	38	250.3	-	-
13	103.5	26	162.2	39	69.4	-	-

DSC TONE CHART

DCS	CODE	DCS	CODE	DCS	CODE	DCS	CODE	DCS	CODE	DCS	CODE
1	023	19	116	37	225	55	325	73	452	91	627
2	025	20	122	38	226	56	331	74	454	92	631
3	026	21	125	39	243	57	332	75	455	93	632
4	031	22	131	40	244	58	343	76	462	94	654
5	032	23	132	41	245	59	346	77	464	95	662
6	036	24	134	42	246	60	351	78	465	96	664
7	043	25	143	43	251	61	356	79	466	97	703
8	047	26	145	44	252	62	364	80	503	98	712
9	051	27	152	45	255	63	365	81	506	99	723
10	053	28	155	46	261	64	371	82	516	100	731
11	054	29	156	47	263	65	411	83	523	101	732
12	065	30	162	48	265	66	412	84	526	102	734
13	071	31	165	49	266	67	413	85	532	103	743
14	072	32	172	50	271	68	423	86	546	104	754
15	073	33	174	51	274	69	431	87	565	-	-
16	074	34	205	52	306	70	432	88	606		
17	114	35	212	53	311	71	445	89	612	-	-
18	115	36	223	54	315	72	446	90	624	-	-

UHF CB OPERATING FREQUENCIES

CH	Frequency (MHz)	CH	Frequency (MHz)	CH	Frequency (MHz)	CH	Frequency (MHz)
1	476.425	21	476.925	41	476.4375	61	476.9375
2	476.450	22	476.950	42	476.4625	62	476.9625
3	476.475	23	476.975	43	476.4875	63	476.9875
4	476.500	24	477.000	44	476.5125	64	477.0125
5	476.525	25	477.025	45	476.5375	65	477.0375
6	476.550	26	477.050	46	476.5625	66	477.0625
7	476.575	27	477.075	47	476.5875	67	477.0875
8	476.600	28	477.100	48	476.6125	68	477.1125
9	476.625	29	477.125	49	476.6375	69	477.1375
10	476.650	30	477.150	50	476.6625	70	477.1625
11	476.675	31	477.175	51	476.6875	71	477.1875
12	476.700	32	477.200	52	476.7125	72	477.2125
13	476.725	33	477.225	53	476.7375	73	477.2375
14	476.750	34	477.250	54	476.7625	74	477.2625
15	476.775	35	477.275	55	476.7875	75	477.2875
16	476.800	36	477.300	56	476.8125	76	477.3125
17	476.825	37	477.325	57	476.8375	77	477.3375
18	476.850	38	477.350	58	476.8625	78	477.3625
19	476.875	39	477.375	59	476.8875	79	477.3875
20	476.900	40	477.400	60	476.9125	80	477.4125

	Emergency use only
	Telemetry / SelCall use only. Voice transmission is inhibited as required by AS/NZS 4365.2011
	Guard band channel. Transmission is inhibited as required by AS/NZS 4365.2011
	Repeater input channels (Duplex)
	Repeater output channels (Duplex)
11	Officially designated call channel
40	Road channel
18	Caravan and motorhome
10	4WD / Offroad

SPECIFICATIONS

ELECTRICAL

General

Compliant Specification:	Meets AS/NZS 4365 for radio communications equipment in the UHF citizen and personal radio service.
Frequency Range TX:	476.425 – 477.4125 MHz
Number of Channels:	80
Channel Spacing:	12.5 kHz
Operation Mode:	Simplex or half duplex with repeater talk around.
Scanning Speed:	25 ms per channel (40 channels per second).
Antenna Impedance:	50 Ohms nominal
Nominal Battery Voltage:	12 V DC
Operating Voltage Range:	10-16 V DC
Battery Polarity:	Negative earth
Standard Test Voltage:	13.8 volts DC
Overvoltage Protection:	25 volts DC maximum. At 18 V DC the channel display flashes 'Hi DC' for 5 seconds on receive. The RF power is reduced and TX flashes on transmit.
Reverse Voltage Protection:	Diode crowbar
Overcurrent Protection:	In-line 2 amp fuse
Operating Temperature:	-10°C to 60°C

Transmitter

RF Output:	5 W
Spurious Emission:	< -70 dBc
Frequency Error:	< ± 1.5 kHz
Modulation:	FM
Maximum Deviation:	< ± 2.5 kHz at + 20 dB AF limiting.

Transmit Frequency Response:	+6 dB per octave 300 Hz to 3 kHz + 1-3 dB
------------------------------	--

Demodulated Audio Signal to Noise:	> 45 dB unweighted
------------------------------------	--------------------

Current Consumption:	1.7 amps with 50 Ohms termination.
----------------------	------------------------------------

Receiver

Intermediate Frequencies:	38.85 MHz, 450 kHz
---------------------------	--------------------

Sensitivity:	-122 dBm for 12 dB SINAD unweighted
--------------	-------------------------------------

Selectivity:	-6 dB at + 3.5 kHz -60 dB at ± 12.5 kHz
--------------	--

Intermodulation Immunity:	-72 dB
---------------------------	--------

Blocking Immunity:	-98 dB
--------------------	--------

Spurious Response Immunity:	70 dB
-----------------------------	-------

Audio Output Power:	3 W average into 4 Ohms
---------------------	-------------------------

Audio Signal to Noise:	> 45 dB unweighted
------------------------	--------------------

Receive Frequency Response:	-6 dB/Octave de-emphasis 300 Hz to 3 kHz + 1-3 dB.
-----------------------------	---

Current Consumption:	< 175 mA muted 750 mA Full volume.
----------------------	---------------------------------------

Conducted Spurious Emission:	< -70 dBm
------------------------------	-----------

MECHANICAL SPECS & CONNECTIONS

Dimensions:	50 (H) x 171 (L) x 112 (D) mm
-------------	-------------------------------

Weight:	646 grams
---------	-----------

12 volt Power Supply:	Two core cable with bulkhead connector in rear panel.
-----------------------	---

Antenna:	SO239 panel socket
----------	--------------------

External Speaker:	3.5 mm mono jack
-------------------	------------------

Microphone Port:	6 way telephone style with rubber strain relief.
------------------	--

Specifications are subject to change without notice or obligation

STANDARD COMMUNICATIONS WARRANTY AGAINST DEFECTS

This warranty against defects is given by Standard Communications Pty Ltd ACN 000 346 814 (We, us, our or GME). Our contact details are set out in clause 2.7.

1. Consumer guarantees

- 1.1 Our goods come with guarantees that cannot be excluded under the Australian Consumer Law. You are entitled to a replacement or refund for a major failure and for compensation for any other reasonably foreseeable loss or damage. You are also entitled to have the goods repaired or replaced if the goods fail to be of acceptable quality and the failure does not amount to a major failure.
- 1.2 To the extent we are able, we exclude all other conditions, warranties and obligations which would otherwise be implied.

2. Warranty against defects

- 2.1 This warranty is in addition to and does not limit, exclude or restrict your rights under the Competition and Consumer Act 2010 (Australia) or any other mandatory protection laws that may apply.
- 2.2 We warrant our goods to be free from defects in materials and workmanship for the warranty period (see warranty table) from the date of original sale (or another period we agree to in writing). Subject to our obligations under clause 1.2, we will at our option, either repair or replace goods which we are satisfied are defective. We warrant any replacement parts for the remainder of the period of warranty for the goods into which they are incorporated.
- 2.3 To the extent permitted by law, our sole liability for breach of a condition, warranty or other obligation implied by law is limited
 - (a) in the case of goods we supply, to any one of the following as we decide –
 - (i) the replacement of the goods or the supply of equivalent goods;
 - (ii) the repair of the goods;
 - (iii) the cost of repairing the goods or of acquiring equivalent goods;
 - (b) in the case of services we supply, to any one of the following as we decide –
 - (i) the supplying of the services again;
 - (ii) the cost of having the services supplied again.
- 2.4 For repairs outside the warranty period, we warrant our repairs to be free from defects in materials and workmanship for three months from the date of the original repair. We agree to

re-repair or replace (at our option) any materials or workmanship which we are satisfied are defective.

- 2.5 We warrant that we will perform services with reasonable care and skill and agree to investigate any complaint regarding our services made in good faith. If we are satisfied that the complaint is justified, and as our sole liability to you under this warranty (to the extent permitted at law), we agree to supply those services again at no extra charge to you.
- 2.6 To make a warranty claim you must before the end of the applicable warranty period (see warranty table), at your own cost, return the goods you allege are defective, provide written details of the defect, and give us an original or copy of the sales invoice or some other evidence showing details of the transaction.
- 2.7 Send your claim to:
Standard Communications Pty Ltd.
PO Box 96 Winston Hills, NSW 2153, Australia.
Tel: (02) 8867 6000 Fax: (02) 8867 6199
Email: servadmin@gme.net.au
- 2.8 If we determine that your goods are defective, we will pay for the cost of returning the repaired or replaced goods to you, and reimburse you for your reasonable expenses of sending your warranty claim to us.

3. What this warranty does not cover

- 3.1 This warranty will not apply in relation to:
 - (a) goods modified or altered in any way;
 - (b) defects and damage caused by use with non Standard Communications products;
 - (c) repairs performed other than by our authorised representative;
 - (d) defects or damage resulting from misuse, accident, impact or neglect;
 - (e) goods improperly installed or used in a manner contrary to the relevant instruction manual; or
 - (f) goods where the serial number has been removed or made illegal.

4. Warranty period

- 4.1 We provide the following warranty on GME and Kingray products. No repair or replacement during the warranty period will renew or extend the warranty period past the period from original date of purchase.

PRODUCT TYPE	WARRANTY PERIOD
477 MHz UHF CB mobile radios	5 years



ISO 9001: 2008
AU9710906
List of certified
characteristics available
at www.sgs.com

For more information call or visit us:

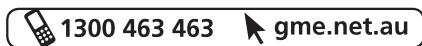

A division of Standard Communications Pty. Ltd.

Head Office: PO Box 96, Winston Hills, NSW 2153, Australia.

New Zealand: PO Box 58, 446 Botany, Auckland, 2163, NZ. T: (09) 274 0955.

All other international enquiries email: export@gme.net.au

Part Number: 310595 Drawing Number: 46885-4

GME

W1

**Remote PTT and programmable function
keys with steering wheel mount**



INSTRUCTION MANUAL



CONTENTS

INTRODUCTION	2	Radio menu options	7
Controls	2	PROGRAMMABLE KEY FUNCTIONS...	9
Replacing the battery	3	Using the channel selector option..	10
INSTALLATION	3	Specifications.....	10
Mounting.....	3	SC CONTRACT WARRANTY	
Installing the remote microphone	6	AGAINST DEFECTS	11
PAIRING.....	7	Contacts	back page

ACCESSORIES SUPPLIED

Remote microphone	Spacer kit	Steering wheel clamp
Adhesive foam	Mounting screw kit	

INTRODUCTION

The W1 wireless remote control is designed to reproduce many of the functions of a standard hand held microphone using wireless technology. The W1 combines a remote Push-To-Talk (PTT) with a user-selectable channel change or scan/priority function in a convenient remote mounted unit.

An external remote microphone is also included for mounting in your vehicle allowing effective hands-free communications while driving.

Once the W1 is connected to your radio, several new options will be enabled in your radio's menu (see '**RADIO MENU OPTIONS**').

CONTROLS

Remote Control Front View

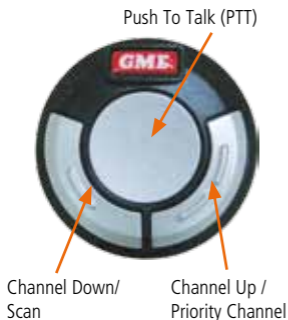

Remote Control Rear View



Activating the W1

The W1 is factory fitted with a 3V button battery. To activate the battery, pull firmly on the blue tab to remove it.



REPLACING THE BATTERY

The W1 operates from a standard CR2025 3V button battery. To replace the battery, slide the battery cover open and remove the old battery. Insert the new battery by sliding it into the compartment with the + side upwards. Refit the battery cover and slide it fully forward until it 'clicks'.

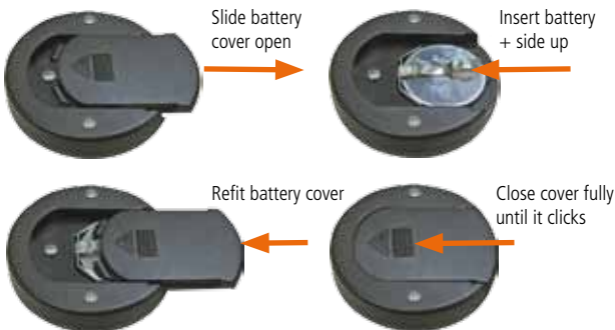

INSTALLATION

Range

The W1 has a line-of-sight range of around 5 – 7 meters depending on the installation. Range may be reduced slightly if the radio or the W1 is mounted close to metal surfaces. This should not have any noticeable effect on most installations, however, if mounting the remote unit in a bus, motor home or other similar sized vehicle please be aware of the range performance when planning your installation.

MOUNTING

The W1 can be mounted directly to the steering wheel using the included steering wheel mounting clamp. Alternatively it can be installed on any flat surface using double sided tape.

NOTE: Installing onto a metallic surface will reduce the signal range.

Steering Wheel Mount

The steering wheel mount is designed to clamp on to the steering wheel in a position where the W1 can be easily reached without distraction while driving.

Temporarily place the W1 into the top clamp then place the top clamp on the steering wheel at the preferred location. Rotate the W1 to the desired angle, then turn the clamp over and secure the W1 using the two screws provided. The clamp has a number of holes and slots to allow the remote control to be rotated and secured at almost any angle.

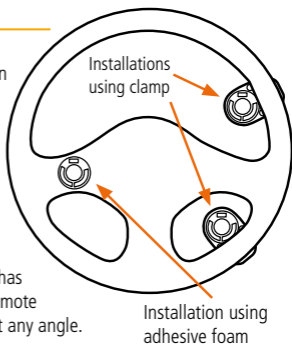

Place the W1 into the clamp

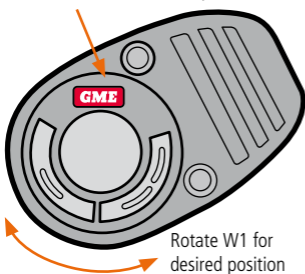

Turn the clamp over and secure the W1 using two screws

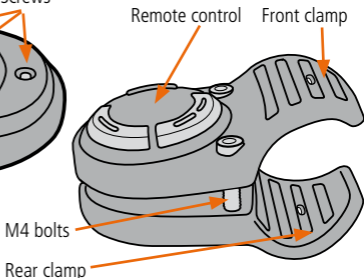
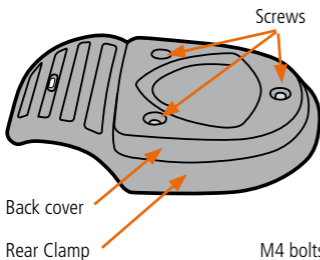
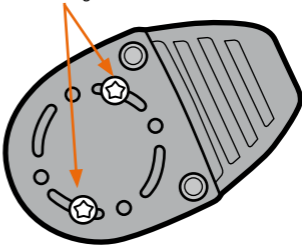

Fit the back plate to the rear clamp using the three screws provided. Finally, reposition the front and rear clamps onto the steering wheel in the chosen

position and fit the two M4 bolts. Tighten firmly so that the clamp does not move when the buttons are pressed. Do not over tighten.

NOTE: If the M4 bolts provided are too short for your steering wheel, they can be replaced with M4 bolts of a suitable length obtained from your local hardware store. Ensure the bolt lengths are not too long, otherwise they may foul on the back cover.

For mounting onto larger steering wheels, a spacer kit is provided which includes two spacers of varying thickness and longer 30mm M4 bolts. If required, fit one or more spacers between the front and rear clamp as shown then tighten firmly using the longer bolts.

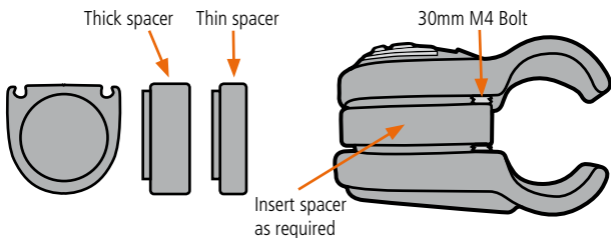

Panel Mount

The W1 can also be mounted onto a flat surface using the supplied adhesive foam. Mount the W1 in a location that is easy to reach without distraction while driving.

NOTE - installing onto a metallic surface will reduce the signal range.

To avoid personal injury, DO NOT install the remote control on any surface associated with your vehicle's airbag.

The adhesive foam is in two sections and is designed to align with the rear mounting holes and the battery cover. To aid in accurately fitting the adhesive foam, proceed as follows;

1. Starting at the top, fold the backing sheet away from the top half of the adhesive foam. Leave the backing sheet attached to the bottom half of the adhesive.
2. With the Remote Unit's GME label at the top, position the sticky side of the adhesive foam onto the back of the Remote Unit, aligning the screw holes and battery compartment with the matching section on the adhesive foam. Press the foam firmly into position.

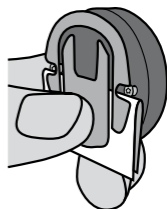

3. Peel away the rest of the backing sheet and press the remainder of the adhesive foam into place.



INSTALLING THE REMOTE MICROPHONE

The external remote microphone should be installed in a location close to your driving position that will allow it to easily pick up your voice while driving. Suggested areas are the driver's side door pillar, sun visor or roof mounted centre console.

Once installed, run the cable to your radio and plug it into either the front or the rear microphone socket. If you are retaining the original hand microphone, we recommend you connect the hand microphone to the front socket and plug the external remote microphone into the rear socket. If a longer cable run is required, an LEM6P 4 metre microphone extension lead is available through your local GME retailer.

NOTE: Installing the external remote microphone is optional. The radio can be configured to use the original hand microphone for hands-free communications if preferred. See '**RADIO MENU OPTIONS**'.

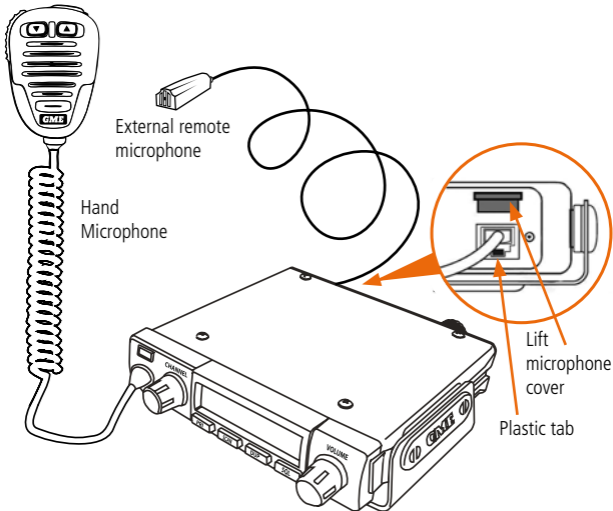

External remote microphone mounting suggestions



PAIRING

Before using your W1 you will need to 'Pair' it with your radio. This one-time process uses a secure internal code to link your W1 exclusively with your radio. Once pairing has been completed, your radio will automatically identify your W1 each time your radio is switched on and will reconnect without further action from you.

To Pair your radio with your W1

1. Switch your radio OFF.
2. Press and Hold the **PTT** button on your radio's hand microphone, then switch your radio ON.
3. 'PAIR' will be displayed, the PTT icon will flash and the radio will beep slowly. Release the **PTT** button.
4. Now press and hold both **Function** keys on the W1.
5. After a few seconds the radio should beep 3 times and 'Pair' will disappear from the display. The W1 is now paired with your radio.



Function keys

NOTE: If you do not complete the Pairing process within 20 seconds the Pairing function will time-out with a low beep and 'PAIR' will disappear from the display. If this happens, restart the process at step 1.

RADIO MENU OPTIONS

Once the W1 has been paired, a number of additional W1 menu items will automatically become available on your radio.

Microphone Input

Your radio has two microphone sockets – on the front and rear panels. The Microphone Input selector allows you to choose which microphone socket will

be used for hands-free transmissions. You can for example plug the original hand microphone into the front socket and the remote microphone into the rear socket and configure the rear socket for hands-free use. Alternately you could choose to install just the original hand microphone and use it for both handheld and hands-free operation.

To select the hands-free microphone input;

1. Press and Hold the **Menu** key until the radio beeps. The radio will enter the Menu mode.
2. Press the **Menu** key repeatedly until 'WMIC1' or 'WMIC2' is displayed.
3. Rotate the **Channel** selector or press the ▲ or ▼ keys to toggle between 'WMIC1' (front microphone socket) or 'WMIC2' (rear microphone socket).
4. Press and hold the **Menu** key (or wait for the Menu function to time-out) to store your setting and exit the Menu.

Microphone Gain Adjustment.

The microphone gain controls the sensitivity of the selected hands-free microphone when operating in hands-free mode. Since the mounting position of the hands-free microphone will vary between installations, the gain control allows you to adjust the microphone sensitivity to ensure your voice is transmitted clearly. When the gain has been adjusted correctly, your hands-free voice level, when heard on a receiving radio, should sound similar to that when using your hand microphone the conventional way.

To adjust the gain, you will require the help of another person with a similar UHF radio.

Begin by sitting in your vehicle in your normal driving position. Select a quiet channel and arrange for someone to listen to your transmission. They should not be too close, as your voice level will not be accurately represented if your signal is overloading their receiver.

1. Hold the original hand microphone in the conventional way and press the **PTT**. Talk into the microphone in a normal voice and get the other person to adjust their volume for a comfortable level. This transmission will give them a reference level for the next stage.
2. Release the **PTT** on the hand microphone (if your hand microphone is also being used as your hands-free microphone, place it in its normal 'hangup' position before continuing).

3. Press the remote **PTT** button and talk again in a normal voice. If the other person indicates that your voice level is now too high or too low, you can adjust the gain as follows.
 - a. Press and Hold the **Menu** key until the radio beeps. The radio will enter the Menu mode.
 - b. Press the **Menu** key repeatedly until 'WGAIN' is displayed.
 - c. Rotate the **Channel** selector or press the ▲ or ▼ keys to adjust the gain. The gain can be adjusted from -12 dB to +30 dB. A level of 0 dB is equivalent to zero gain.
4. When the required gain has been set, press and hold **Menu** (or wait for the Menu function to time-out) to store your setting and exit the Menu.

Repeat from step 1 until your hands-free voice level is similar to talking into your hand microphone. Use only as much gain as required for your voice to be heard clearly. Excessive microphone gain will also amplify vehicle noise which can make your voice difficult to hear clearly when driving. We recommend you also test your hands-free microphone whilst driving to check for background noise and readjust the gain if necessary.

NOTE: Do not attempt to adjust the microphone gain while driving

NOTE: Always stop your vehicle before adjusting the microphone gain

PROGRAMMABLE KEY FUNCTIONS

The two function keys on the remote unit can be programmed to provide either channel up/down selection or scanning/priority functions. Please refer to your radio's user manual for more details on using these features.

Channel Selection Option (WCHNL)

To select your preferred option;

1. Press and Hold the **Menu** key until the radio beeps. The radio will enter the Menu mode.
2. Press the **Menu** key repeatedly until 'WCHNL' or 'WSCAN' is displayed.



3. Rotate the **Channel** selector or press the ▲ or ▼ keys to toggle between 'WCHNL' (Channel Selector) or 'WSCAN' (Scan/Priority) functions.
4. Press and hold **Menu** (or wait for the Menu function to time-out) to store your setting and exit the Menu.

Scan/Priority Opti on (WSCAN)



USING THE CHANNEL SELECTOR OPTION

Briefly press the **left** key to select a lower channel or the **right** key to select a higher channel.

Press and hold the **left** key to quickly step downwards through the channels or the **right** key to quickly step upwards. Release the key to stop.

USING THE SCAN/PRIORITY OPTION

Briefly press the **left** key to start or stop scanning. Press and hold the **left** key to add or remove the currently selected channel from the scan memory.

Briefly press the **right** key to switch immediately to the priority channel. Press and hold the **right** key to store the currently selected channel as the priority channel.

SPECIFICATIONS

Electrical

Compliant specification: Meets AS/NZS 4268:2008 for short range devices

Frequency range TX: 2.4 GHz

Operating temperature: -10°C to 60°C

Current consumption: 2 uA on standby, 12 mA on transmit

RF output: 4 dBm

Battery type: CR2025

Mechanical

Dimensions: 40 mm diameter x 14 mm (h)

Weight: 12 grams

STANDARD COMMUNICATIONS CONTRACT WARRANTY AGAINST DEFECTS

This warranty against defects is given by Standard Communications Pty Ltd ACN 000 346 814 (We, us, our or GME). Our contact details are set out in clause 2.7.

1. Consumer guarantees

- 1.1 Our goods come with guarantees that cannot be excluded under the Australian Consumer Law. You are entitled to a replacement or refund for a major failure and for compensation for any other reasonably foreseeable loss or damage. You are also entitled to have the goods repaired or replaced if the goods fail to be of acceptable quality and the failure does not amount to a major failure.
- 1.2 To the extent we are able, we exclude all other conditions, warranties and obligations which would otherwise be implied.

2. Warranty against defects

- 2.1 This warranty is in addition to and does not limit, exclude or restrict your rights under the Competition and Consumer Act 2010 (Australia) or any other mandatory protection laws that may apply.
- 2.2 We warrant our goods to be free from defects in materials and workmanship for the warranty period (see warranty table) from the date of original sale (or another period we agree to in writing). Subject to our obligations under clause 1.2, we will at our option, either repair or replace goods which we are satisfied are defective. We warrant any replacement parts for the remainder of the period of warranty for the goods into which they are incorporated.
- 2.3 To the extent permitted by law, our sole liability for breach of a condition, warranty or other obligation implied by law is limited
 - (a) in the case of goods we supply, to any one of the following as we decide -
 - (i) the replacement of the goods or the supply of equivalent goods;
 - (ii) the repair of the goods;
 - (iii) the cost of repairing the goods or of acquiring equivalent goods;
 - (b) in the case of services we supply, to any one of the following as we decide –
 - (i) the supplying of the services again;
 - (ii) the cost of having the services supplied again.
- 2.4 For repairs outside the warranty period, we warrant our repairs to be free from defects in materials and workmanship for three months from the date of the original repair. We agree to re-repair or replace (at our option) any materials or workmanship which we are satisfied are defective.
- 2.5 We warrant that we will perform services with reasonable care and skill and agree to investigate any complaint regarding our services made in good faith. If we are satisfied that the complaint is justified, and as our sole liability to you under this warranty (to the extent permitted at law), we agree to supply those services again at no extra charge to you.
- 2.6 To make a warranty claim you must before the end of the applicable warranty period (see warranty table), at your own cost, return the goods you allege are defective, provide written details of the defect, and give us an original or copy of the sales invoice or some other evidence showing details of the transaction.

- 2.7 Send your claim to: Standard Communications Pty Ltd. Unit B, 22-24 College Street, Gladesville, NSW 2111, Australia. Telephone: (02) 9879 8888 Fax: (02) 9816 4722. Email: servadmin@gme.net.au
- 2.8 If we determine that your goods are defective, we will pay for the cost of returning the repaired or replaced goods to you, and reimburse you for your reasonable expenses of sending your warranty claim to us.

3. What this warranty does not cover

- 3.1 This warranty will not apply in relation to:
- (a) goods modified or altered in any way;
 - (b) defects and damage caused by use with non Standard Communications products;
 - (c) repairs performed other than by our authorised representative;
 - (d) defects or damage resulting from misuse, accident, impact or neglect;
 - (e) goods improperly installed or used in a manner contrary to the relevant instruction manual; or
 - (f) goods where the serial number has been removed or made illegal.

4. Warranty period

- 4.1 We provide the following warranty on GME and Kingray products. No repair or replacement during the warranty period will renew or extend the warranty period past the period from original date of purchase.

PRODUCT TYPE	WARRANTY PERIOD
Wireless remote	3 years



A division of Standard Communications Pty Ltd

Head Office: Locked Bag 2086, North Ryde NSW 1670, Australia. T: (02) 9844 6666 F: (02) 9844 6600.

Melbourne: 7 Micro Circuit, Dandenong South, Vic. 3165. T: (03) 9798 0988 F: (03) 9798 0177

Adelaide: 14 Phillips Street, Thebarton, SA 5031. T: (08) 8234 2633 F: (08) 8234 5138

Perth: Unit 1, 10-12 Harvard Way, Canning Vale, WA 6155. T: (08) 9455 5744 F: (08) 9455 3110

Brisbane: Unit 1, 89-101 Factory Road, Oxley, Qld. 4075. T: (07) 3278 6444 F: (07) 3278 6555

Sydney: Unit B, 22-24 College Street, Gladesville, NSW 2111. T: (02) 9879 8888 F: (02) 9816 4722

Auckland: 2/24 Bishop Dunn Place, East Tamaki, Manukau NZ 2013. T: (09) 274 0955 F: (09) 274 0959

For customers outside Australia and New Zealand, please contact your local GME retailer or email: export@gme.net.au www.gme.net.au